

ECOCOCON® STRAW WALL SYSTEM

# Assembly Guide



# Table of Contents

<b>Verifying Deliveries and Pre-assembly Checklist</b>	<b>3</b>
<b>Safety Notice and Handling Protocols</b>	<b>4</b>
<b>Panel Labels and Types</b>	<b>5</b>
<b>Panel Layout Plan</b>	<b>6</b>
<b>Assembly Sequence</b>	<b>7</b>
<b>Mounting Tools</b>	<b>8</b>
<b>Materials</b>	<b>9</b>
<b>Wall System Assembly</b>	<b>10</b>
Unloading	11
Temporary Storage on Building Site	13
Temporary Storage in a Storage Building	14
Preparing the Base Plate	15
Connections to Existing Structures	16
Lifting the Panels	17
Panel Assembly	18
Scheme of Screws for Connecting the Panels	22

Lintel Assembly	23
Narrow Lintel Assembly	24
Airtight Membrane Installation	26
Metal Plates and Braces	28
Temporary Weather Protection	29
Top Plate	30
Straw Wall Penetrations	32
Window and Door Installation	34
Wood Fibre Board	36
Connecting Partitions to Wall	37

<b>Interior Installations</b>	<b>38</b>
Rules and Recommendations	39
Electrical Installations	40
Service Void for Plumbing	43
Interior Clay Plaster System	44
Wall Mounts	46

<b>About us</b>	<b>47</b>
-----------------	-----------



# Verifying Deliveries and Pre-assembly Checklist

## Upon delivery

- » Inspect the goods visually for possible damage that might have occurred during transport and report it immediately in the CMR (consignment note) document.
- » If you find any fault or damage, photo-document it and consult the warranty for the procedure to report it.
- » Check the straw humidity level of panels with a calibrated moisture meter, it must not exceed 20%.
- » Check the delivery documents carefully.

## Delivery documents

With delivery you should receive the following documents :

- » **Delivery slip** - check if all goods have been delivered, paying particular attention to small items such as screws and dowels.
- » **Acceptance certificate** - check if all manufactured items were delivered and measure the humidity level in the straw.
- » **Packing list** - shows how the panels are packaged together.
- » **CMR document** - please sign this document once all items have been accounted for and return to the driver.
- » **Declaration of Performance (DoP)**.

- » **Warranty** - consult the Warranty for handling instructions and warranty procedure.
- » **Panel Project** - use this document for assembly on site.
- » **Assembly Guide** - follow this document as an instructional guide.

## Pre-assembly checklist

Check the building plans so that:

- » The exterior of the wall construction and details are vapour-permeable.
- » The airtight connections of the wall system to adjacent elements are clearly indicated.
- » The Straw Wall System begins above the floor level or the wall base is sealed with waterproof membrane.
- » There is a waterproofing membrane between foundations and the base plate.



Always follow the architectural and structural drawings. If the Panel Project specifies different screw or component placements, these take precedence over the Assembly Guide.



# Safety Notice and Handling Protocols

## Protect against water and moisture!

- » EcoCocon panels have to be fully protected from any rain/water during unloading, storage and mounting.
- » To avoid water damage, do not unload the panels in severe rain. Postpone delivery or ask the driver to wait. If the driver persists in unloading in heavy rain, please call the local EcoCocon Technical Sales Consultant.
- » Consult this guide for detailed storage instructions.
- » After completing the wall assembly, do not leave the temporary plastic sheeting on the inner surface for more than two weeks.

## Protect against fire!

- » The panels must not be mounted if there is an open fire source within 82 Feet.
- » It is strictly prohibited to smoke within 33 Feet of the building site until construction work is completed.

## Ensure airtightness!

- » Follow the details properly to secure airtightness.
- » Any top layers or airtight membranes have to provide a diffusion-open wall system.

## Use Assembly Guide

- » For best results and to ensure your warranty, use this Assembly Guide as an instruction tool.

## Follow the regulations

- » Always comply with health and safety rules when working with the EcoCocon wall system.
- » Check that our general recommendations comply with local regulations and structural requirements specific to your project.



Always follow the architectural and structural drawings. If the Panel Project specifies different screw or component placements, these take precedence over the Assembly Guide.

# Panel Labels and Types

## All panels are marked with a label containing:

- » Project name and panel dimensions
- » Panel number (panel type and production number)
- » Wall section indicating precise location of the panel
- » The Lorry-Pack indicating the sequence number of the lorry for delivery. To specify the panel's position, the pack number is provided along with the horizontal and vertical row within the pack.
- » QR code linked to this Assembly Guide

## Panel types:

- P – Standard panel
- B – Braced panel
- I – Inclined panel
- C – Column panel
- L – Lintel panel
- S – Sill panel

## Other elements:

- X – Box element
- G – Additional timber
- Y – Additional plywood
- W – Window plywood reveals

Panel type and production number

Location of the panel within the wall

The lorry and the pack number specify horizontal and vertical row

Project name and panel dimensions

Number of national technical assessment

Link to this Assembly Guide

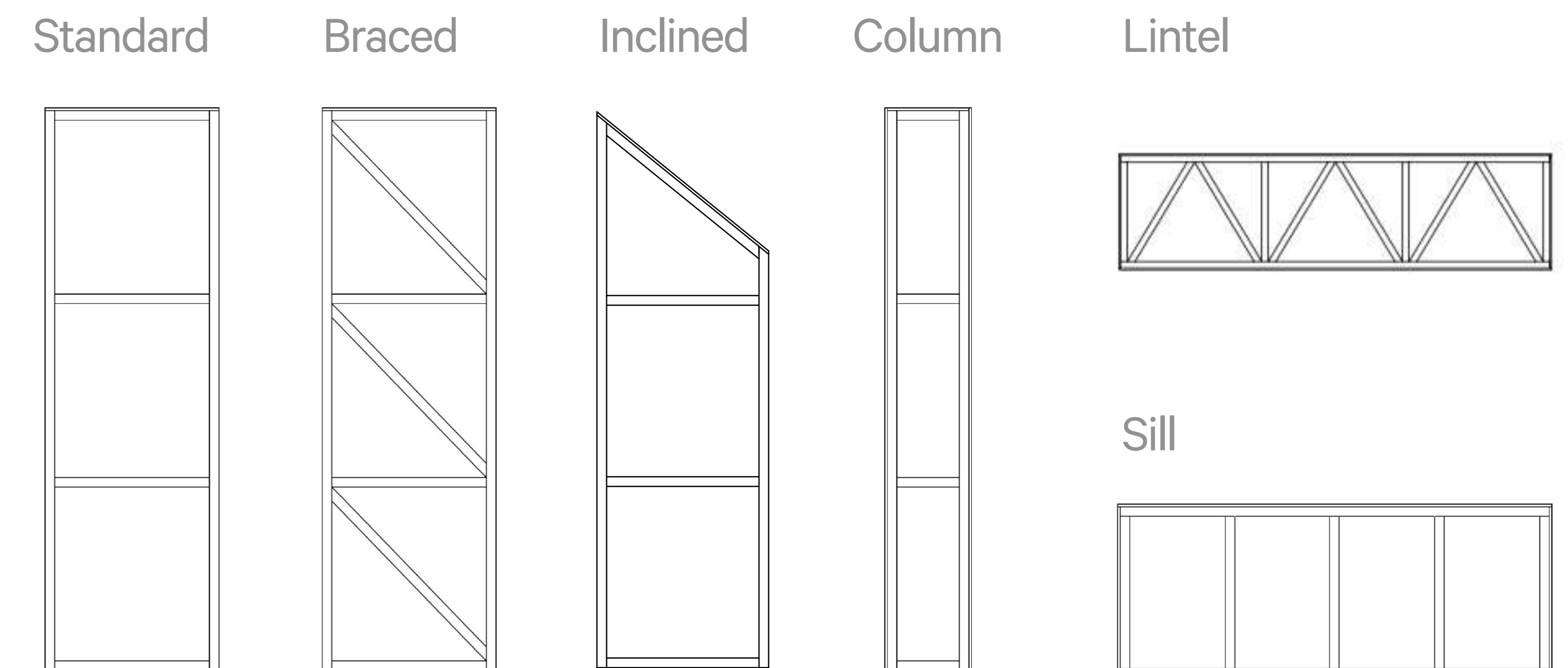

# Panel Layout Plan

The Panel Project serves as a layout plan, with dimensions provided in the elevation drawings.

## The Panel Project consists of:

- » list of panels with dimensions and weight
- » additional timber and plywood list
- » list of wall openings
- » wall number legend and 3D view of assembly
- » plan view
- » elevations with dimensions

The elevations are always oriented from the exterior. The drawings include the thickness of the plywood boards to be installed in the reveals of openings (supplied with EcoCocon panels, see Lintel Assembly p. 23).

Measurements of openings are always from plywood to plywood.

 Lintel panels, braced panels, and box elements must be installed exactly as shown, as they have asymmetrical properties.

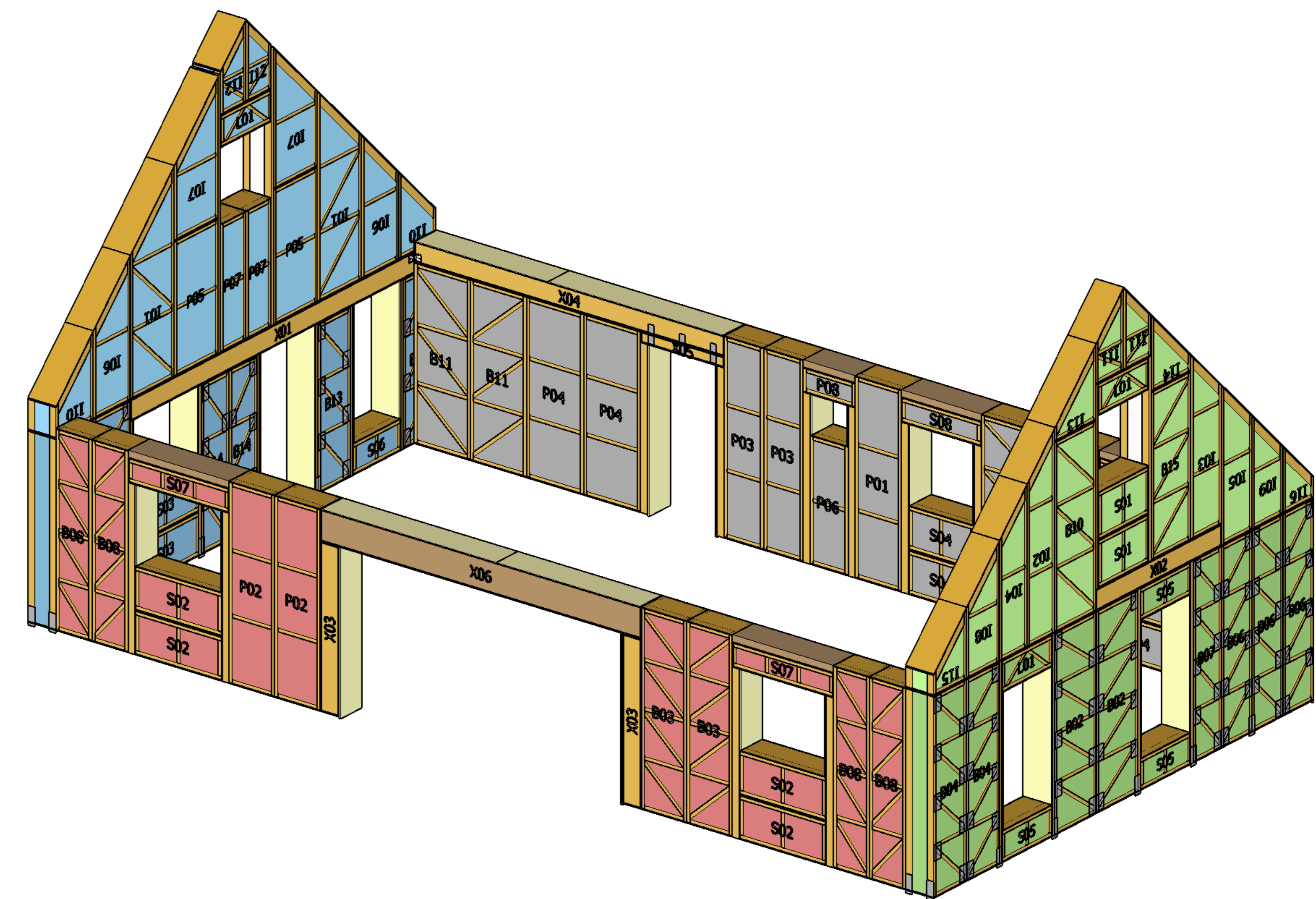

# Assembly Sequence

Follow this step-by-step assembly sequence to ensure the correct and efficient installation of EcoCocon panels, from the base plate to the final insulation layer.

## Correct assembly sequence:

1. base plate
2. walls
3. membrane
4. top plate
5. roof
6. windows
7. wood-fiber boards



It is essential to install the roof immediately after assembling the walls to protect the structure from weather exposure.



# Mounting Tools

Installation of the EcoCocon Straw Wall System requires only the following basic carpentry tools:

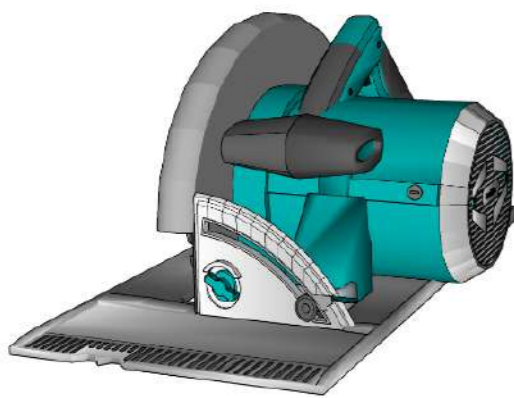

circular saw

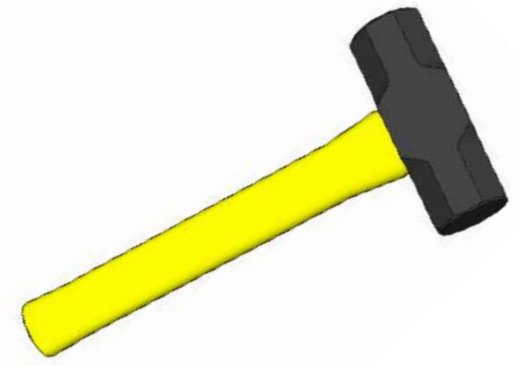

lump hammer (11 Pound)



ratchet straps

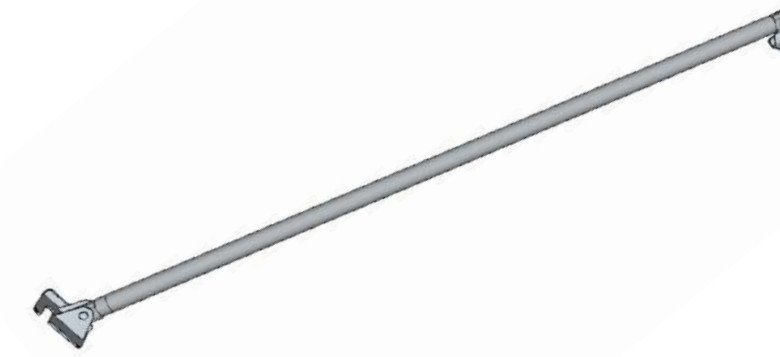

temporary metal angled wall brace



impact driver & long bit holder



stanley type knife/scissors



ladder/scaffolding

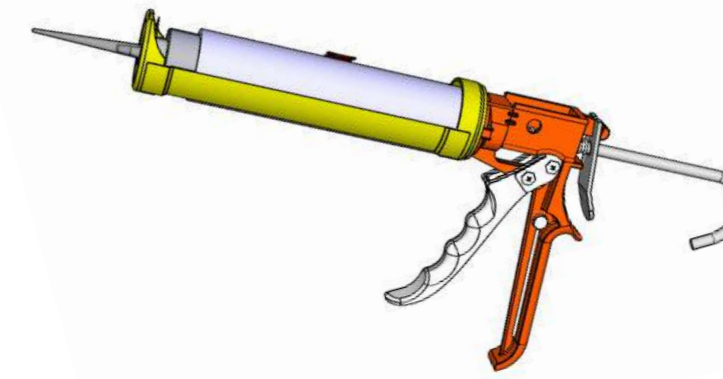

glue gun

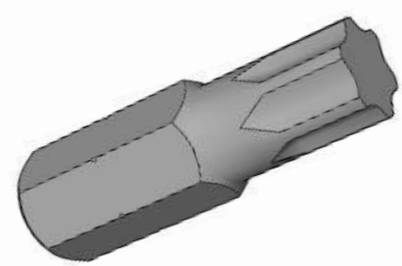

drill bit sizes - Torx 30 & 40



stapler

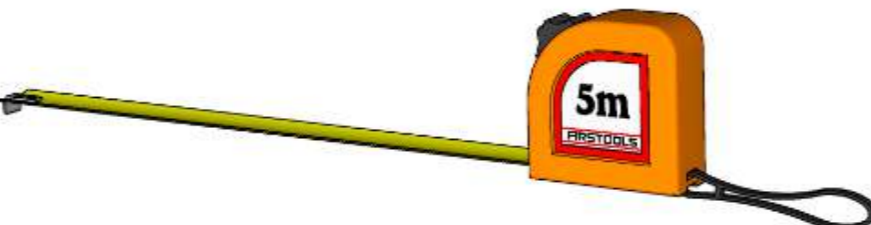

measuring tape

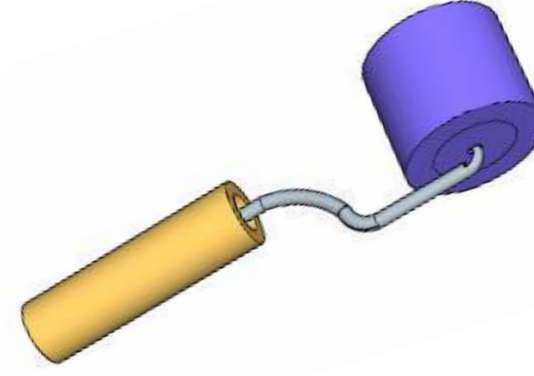

seam roller



variety of clamps of different lengths (at least 3 Feet long, could include ratchets)

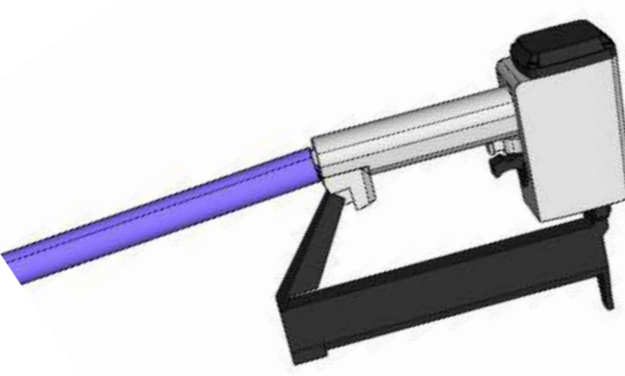

pneumatic air staple gun for mounting plywood strips (or 1 3/8 - inch screws)



calibrated moisture meter



pencil/marker



# Materials

## Materials in delivery

- » These are materials usually included in the delivery, depending on order:
- » EcoCocon panels
- » Box elements
- » plywood for window reveal ( 7/8 inches)
- » screws for panel assembly
- » wooden dowels for panel assembly
- » breather membrane
- » air sealing tape
- » plywood strips (3 1/2 inches and 1 3/4 inches wide, 1/4 inch thick) for fixing the breather membrane
- » metal plates, braces, and screws for additional reinforcement and anchoring to the foundation (if specified in the Panel Project)
- » transparent plastic sheeting for temporary weather protection on the interior side

### In some cases the order may also include:

- » external fibre board insulation
- » clay plaster
- » wood fibre board ( 1/4 inches) for plaster support internally
- » extra timber and plywood

## Materials to be prepared

Apart from the materials included in the delivery, you will also need:

- » heavy-duty tarpaulin at least 0.05 pounds per ft<sup>2</sup> (temporary weather protection) and cardboard corners to prevent the tarpaulin from tearing
- » 1 1/8 inches staples (or 1 3/8 inches screws) for fixing plywood strips
- » foam weather strip tape (or EPDM strip, or weather barrier such as Wetguard or Vista) between membrane and top plate
- » nails or screws for fixing exterior wood fibre board insulation (follow manufacturer's instructions)

Please note that materials for building the foundation, base plate, top plate, roof or final exterior and interior finish are NOT included in the delivery.



Always follow the architectural and structural drawings. If the Panel Project specifies different screw or component placements, these take precedence over the Assembly Guide.



# Wall System Assembly



# Unloading

01

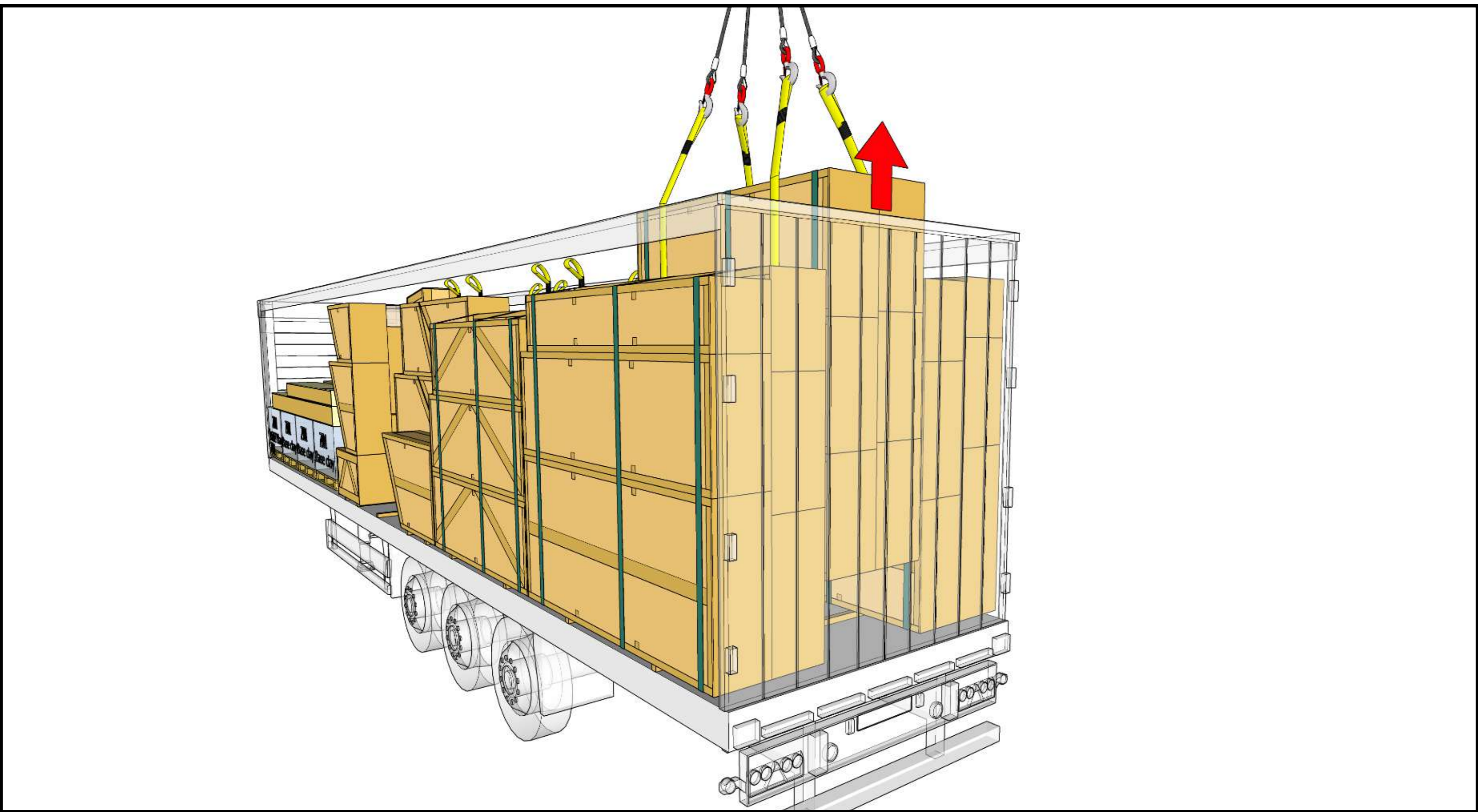

When using a crane, start unloading from the middle package, using pre-installed straps.

02

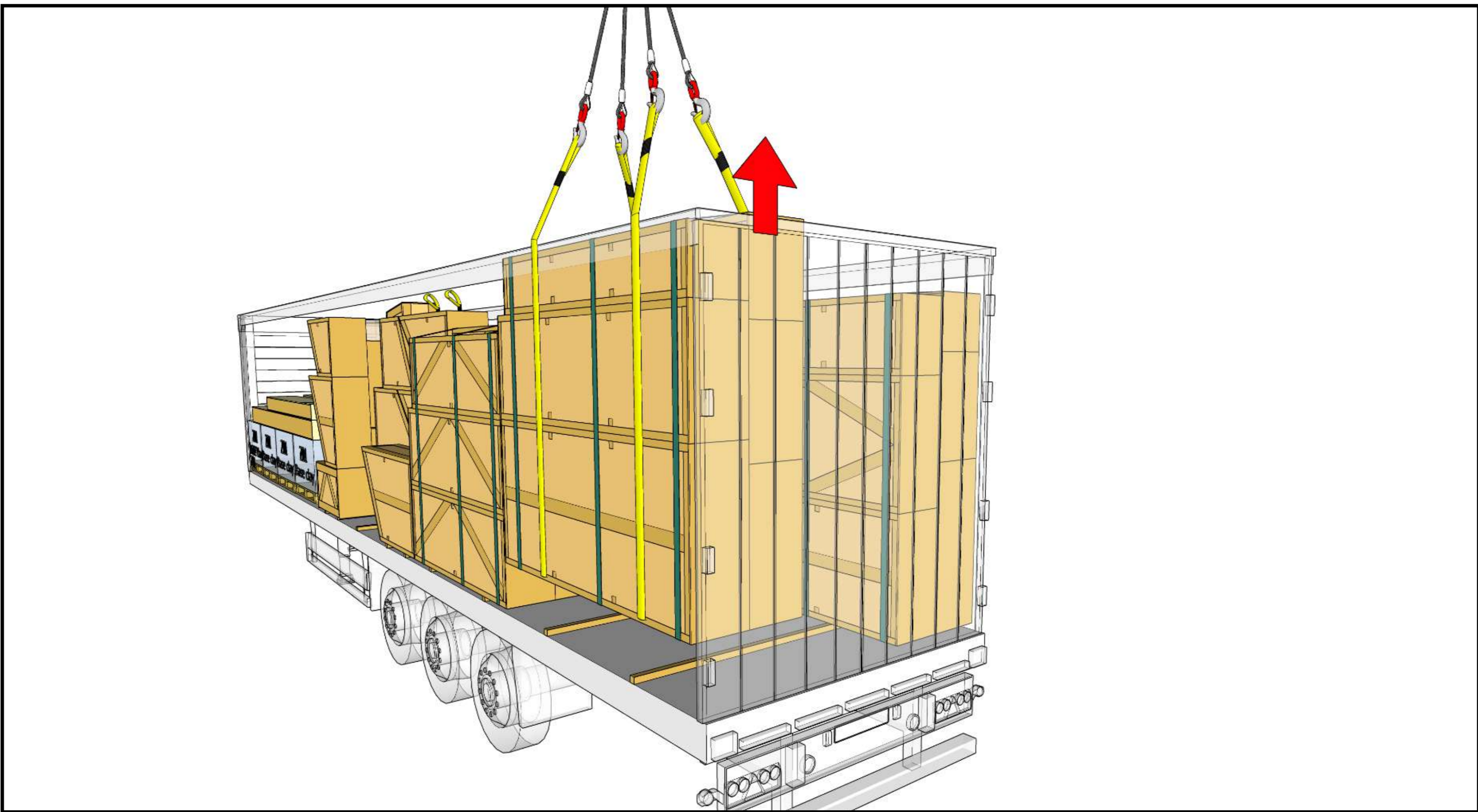

Reuse the straps on the side packages.

03

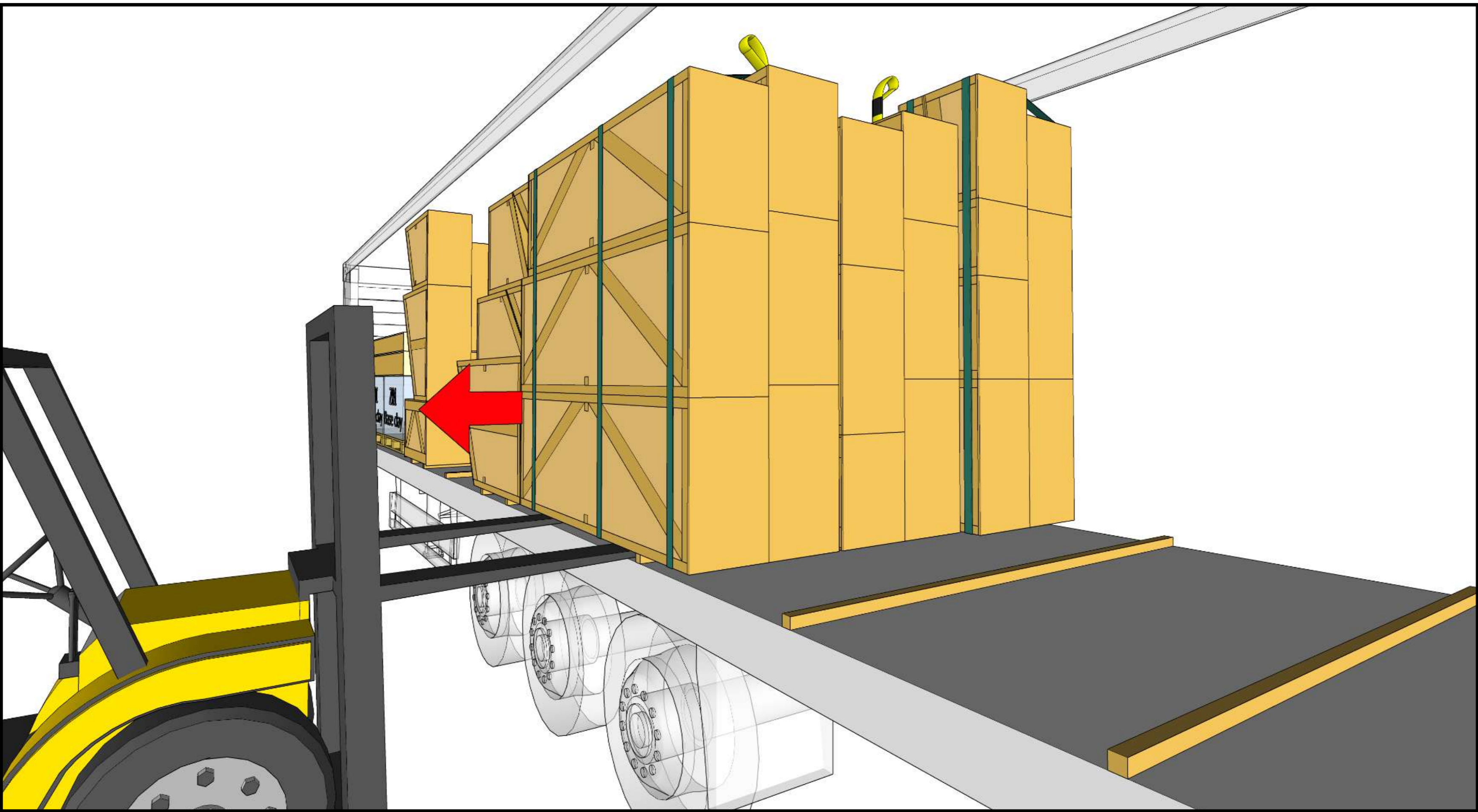

Or unload from the side with a forklift.

04

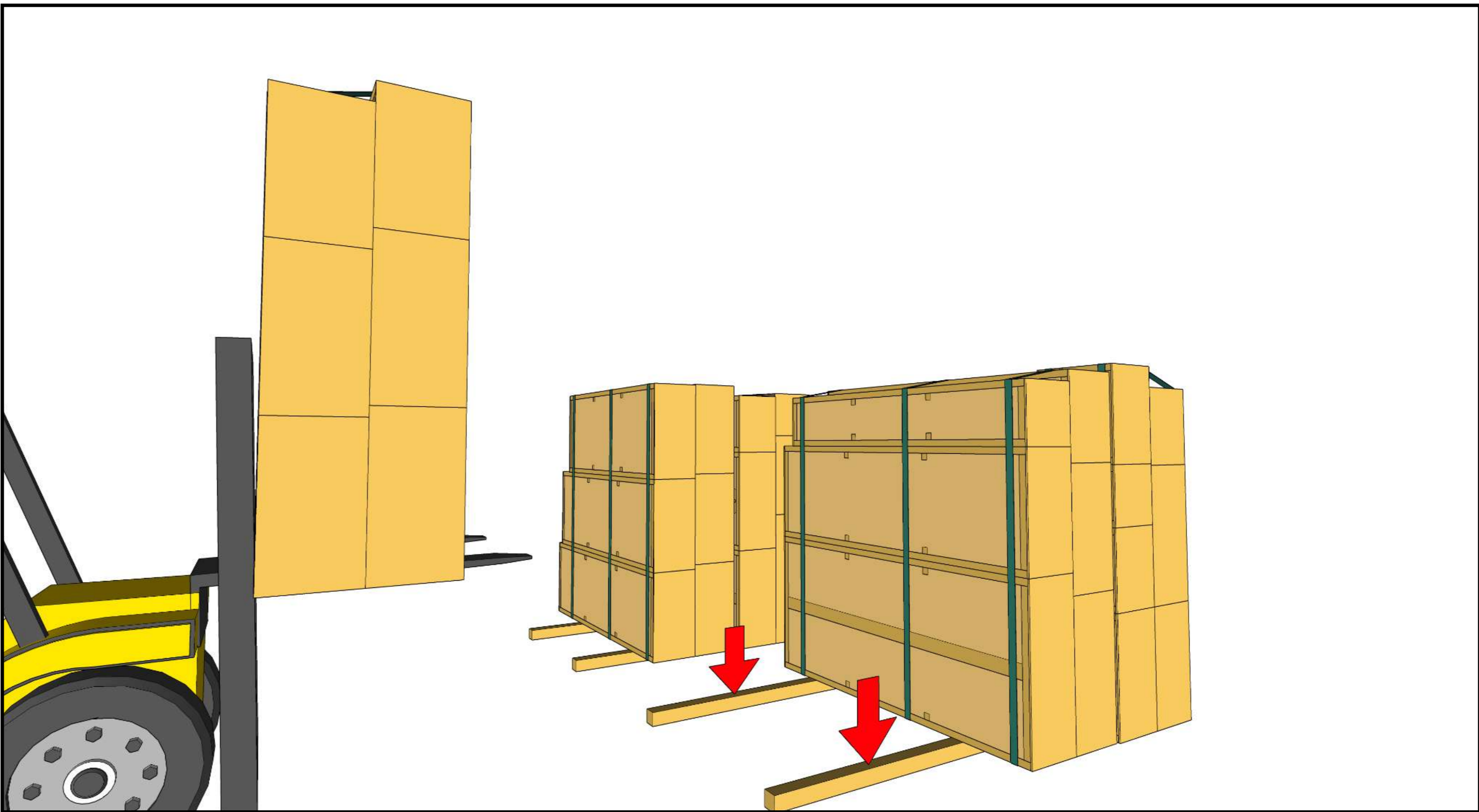

Always keep the panels off the ground, place timber battens beneath.



05

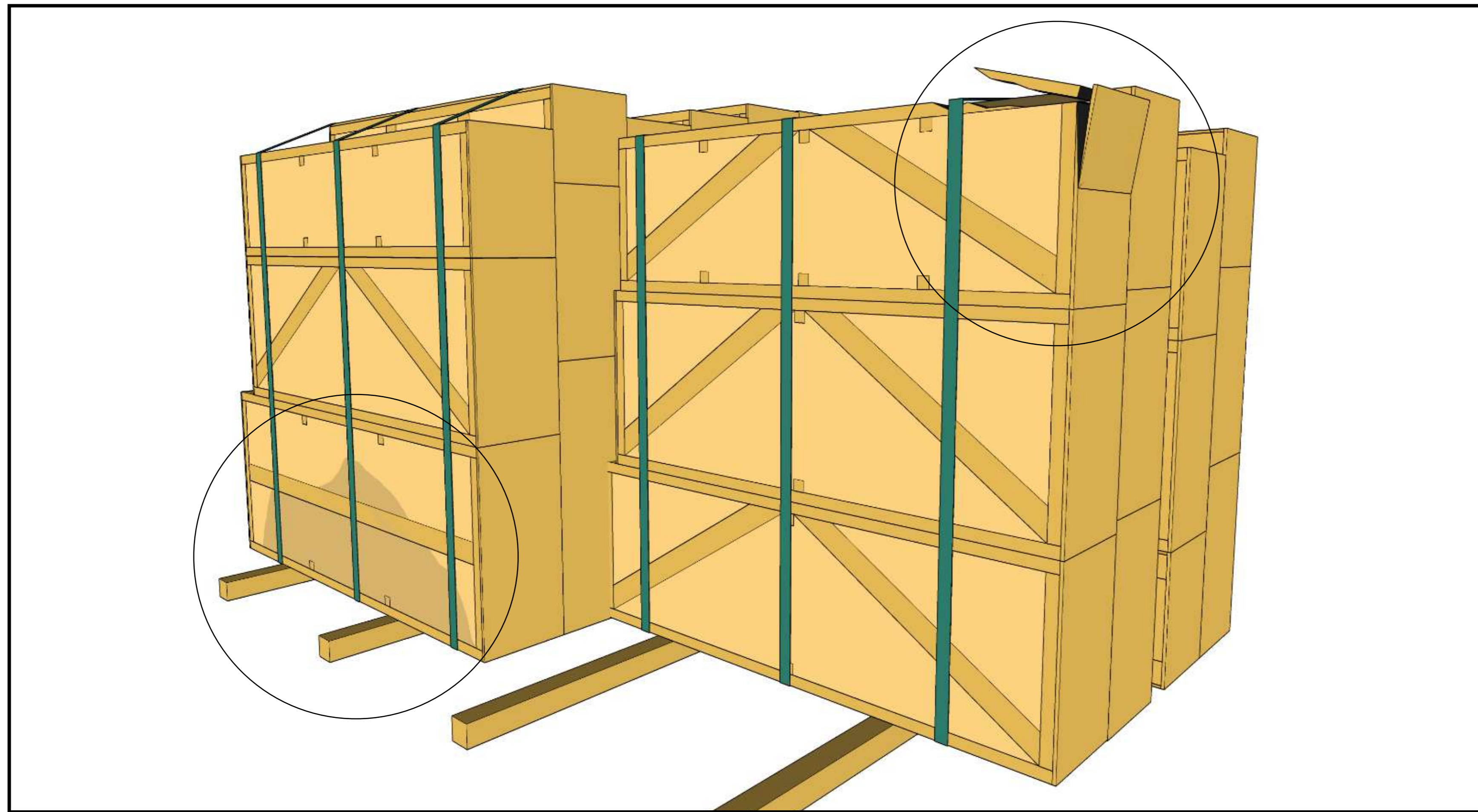

Immediately after unloading, check the panels visually for any mechanical or moisture damage. In case of damage, follow the warranty procedure.

06

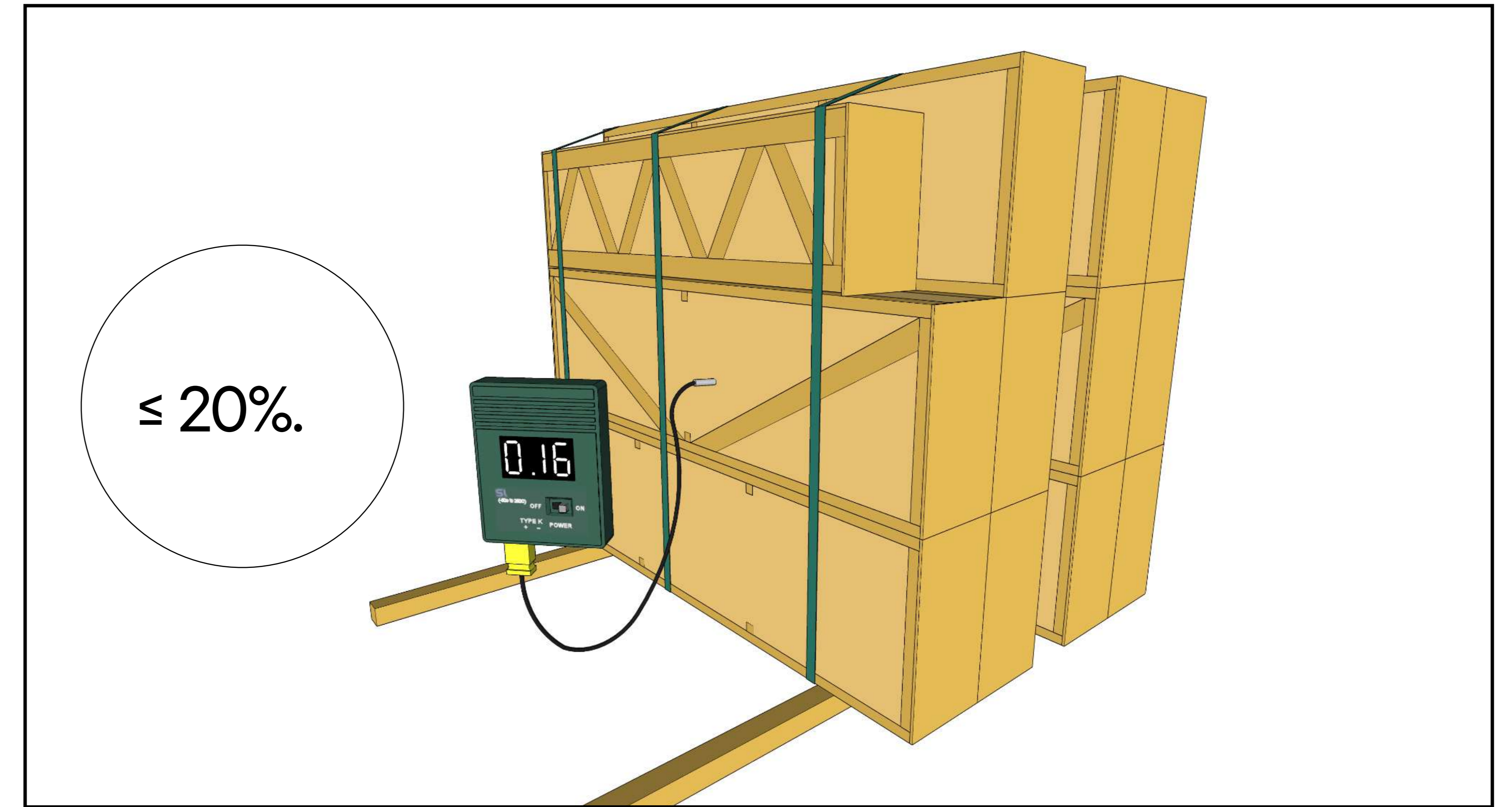

Check the humidity of delivered panels with a calibrated moisture meter. It must not exceed 20%.

07

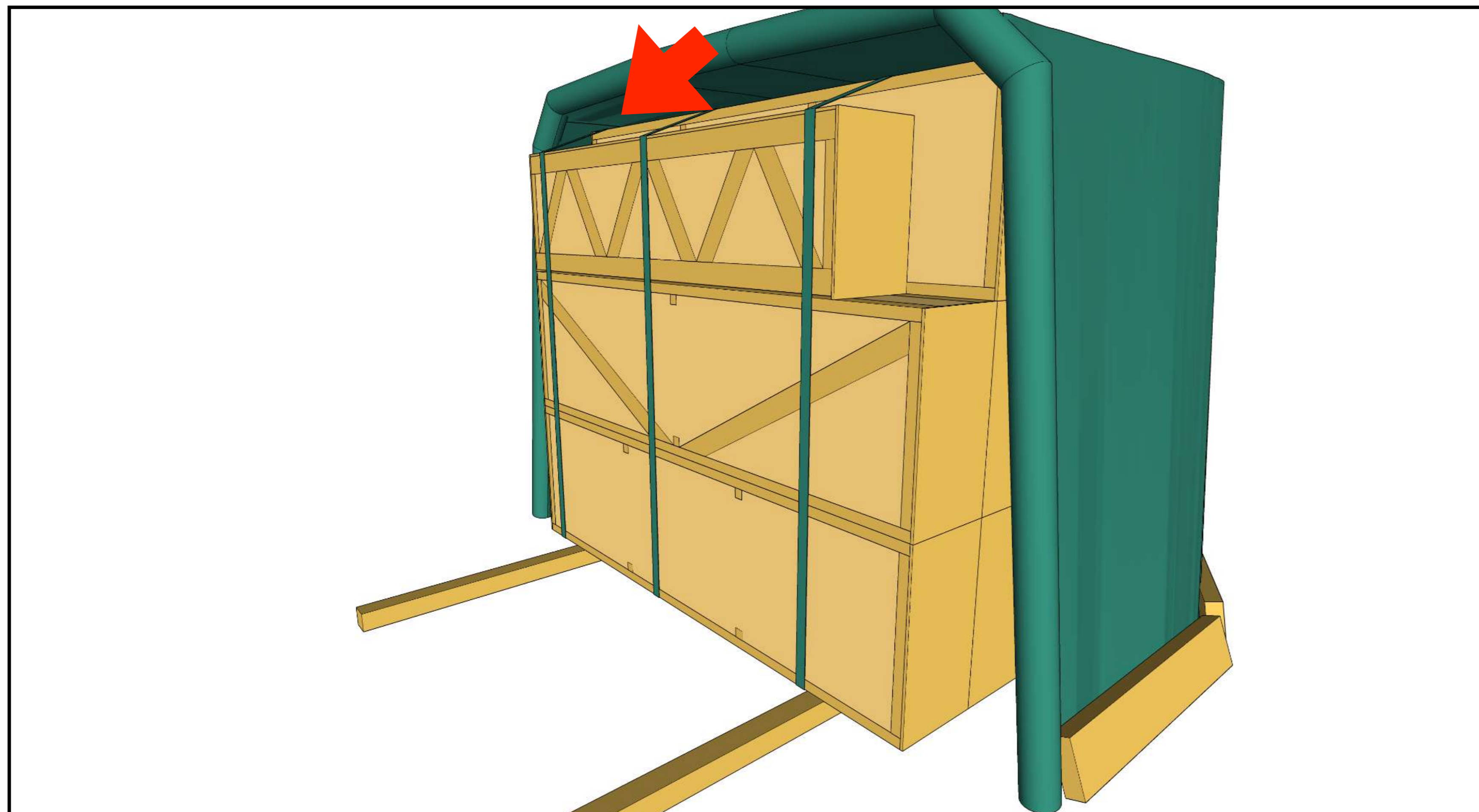

Protect panels immediately after unloading by using a heavy-duty tarpaulin at least 0.05 pounds per ft<sup>2</sup>.

# Temporary Storage on Building Site

01

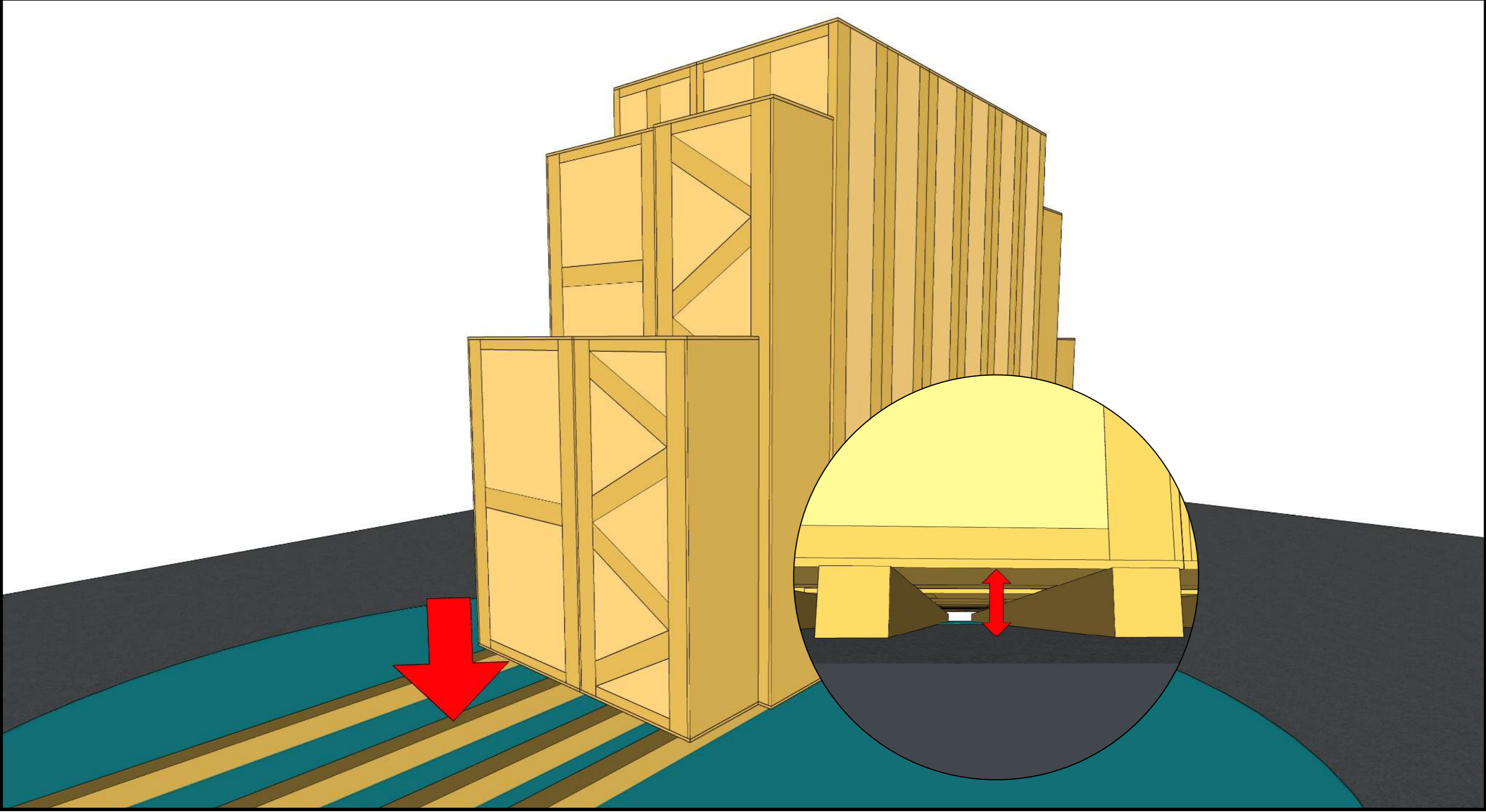

Keep panels off the ground to protect them from moisture or flooding after rainfall.

02

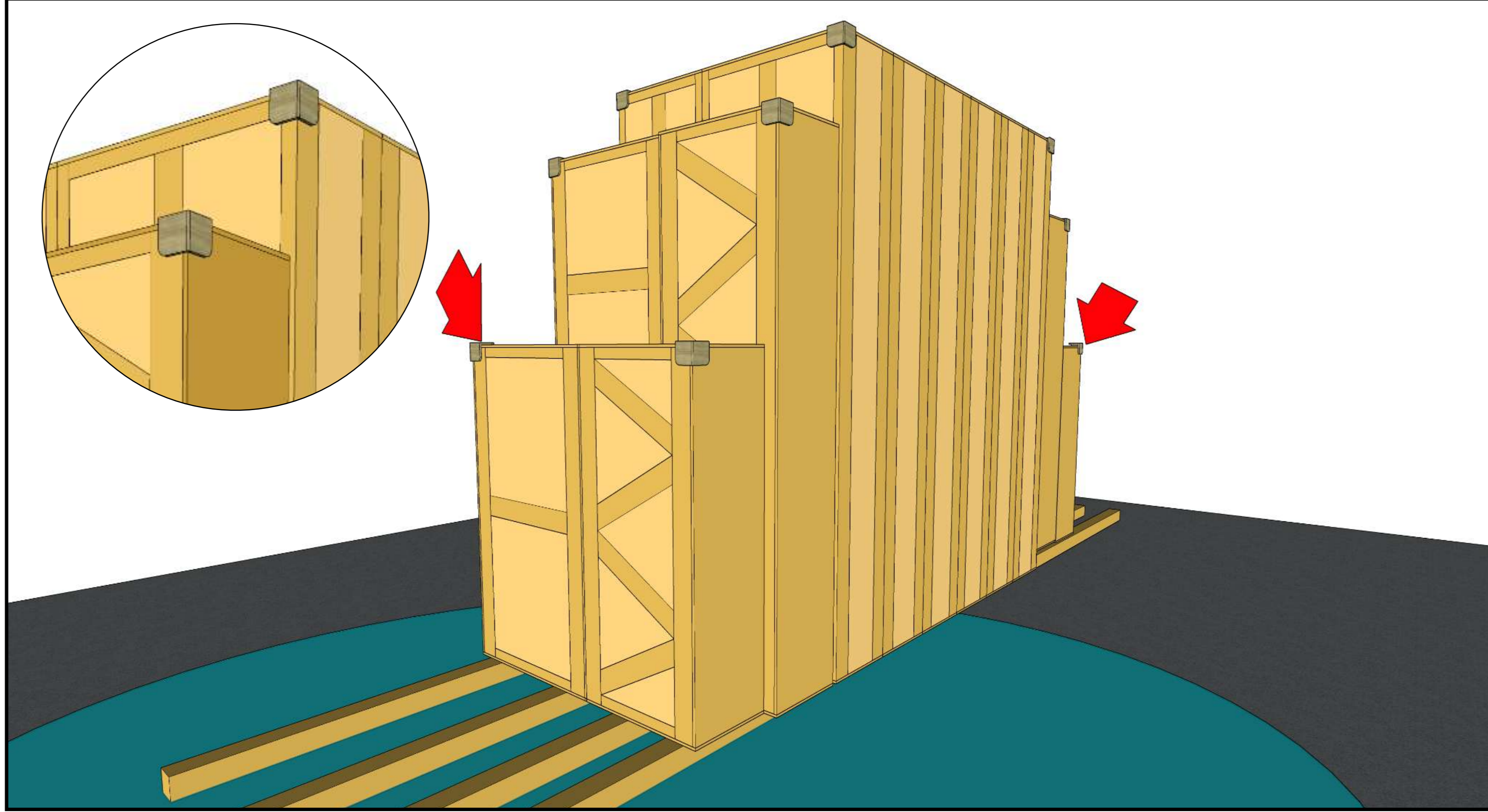

Use protective cardboard corners to prevent the tarpaulin from tearing.

03

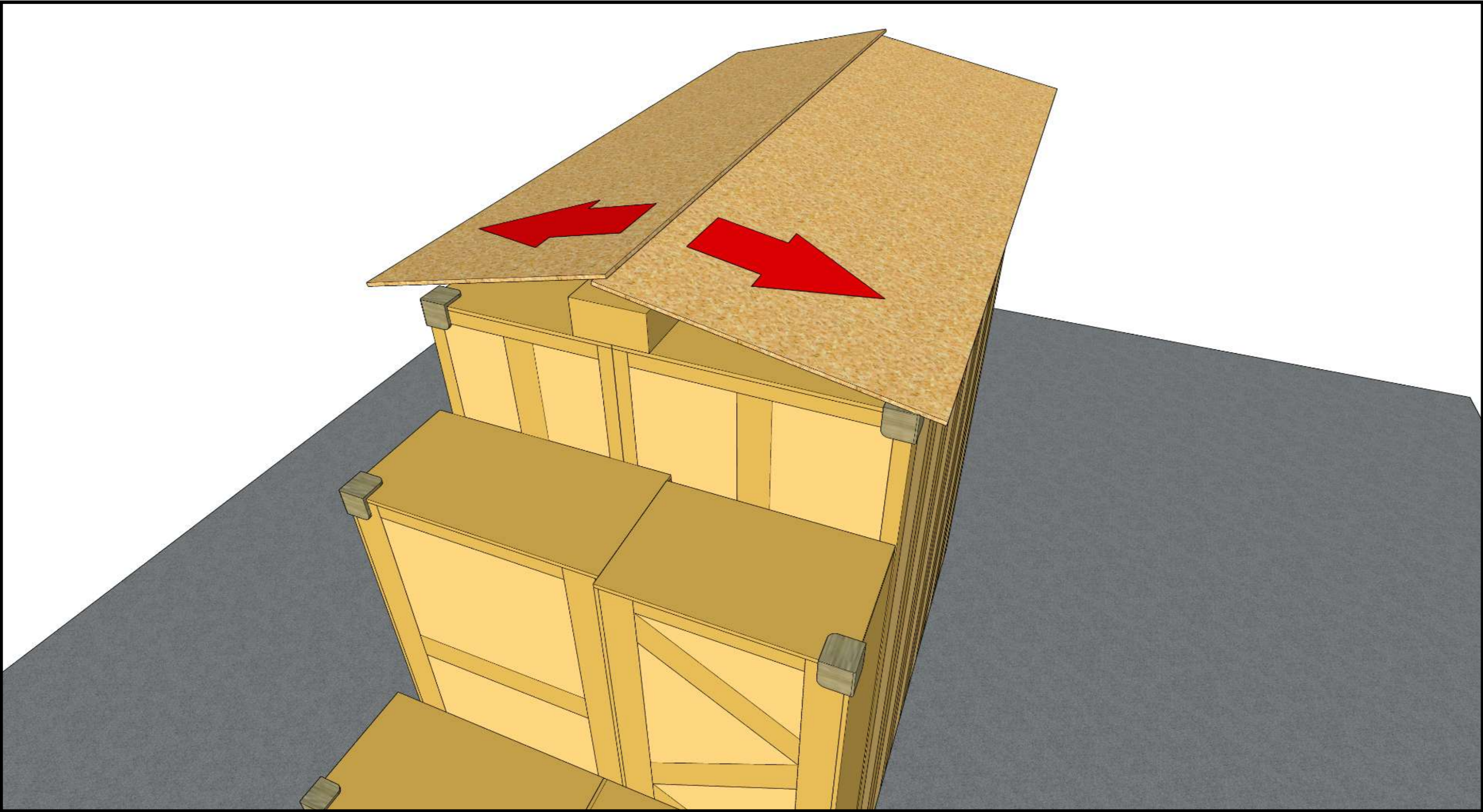

Create a sloping support under the tarpaulin to allow rainwater to drain away.

04

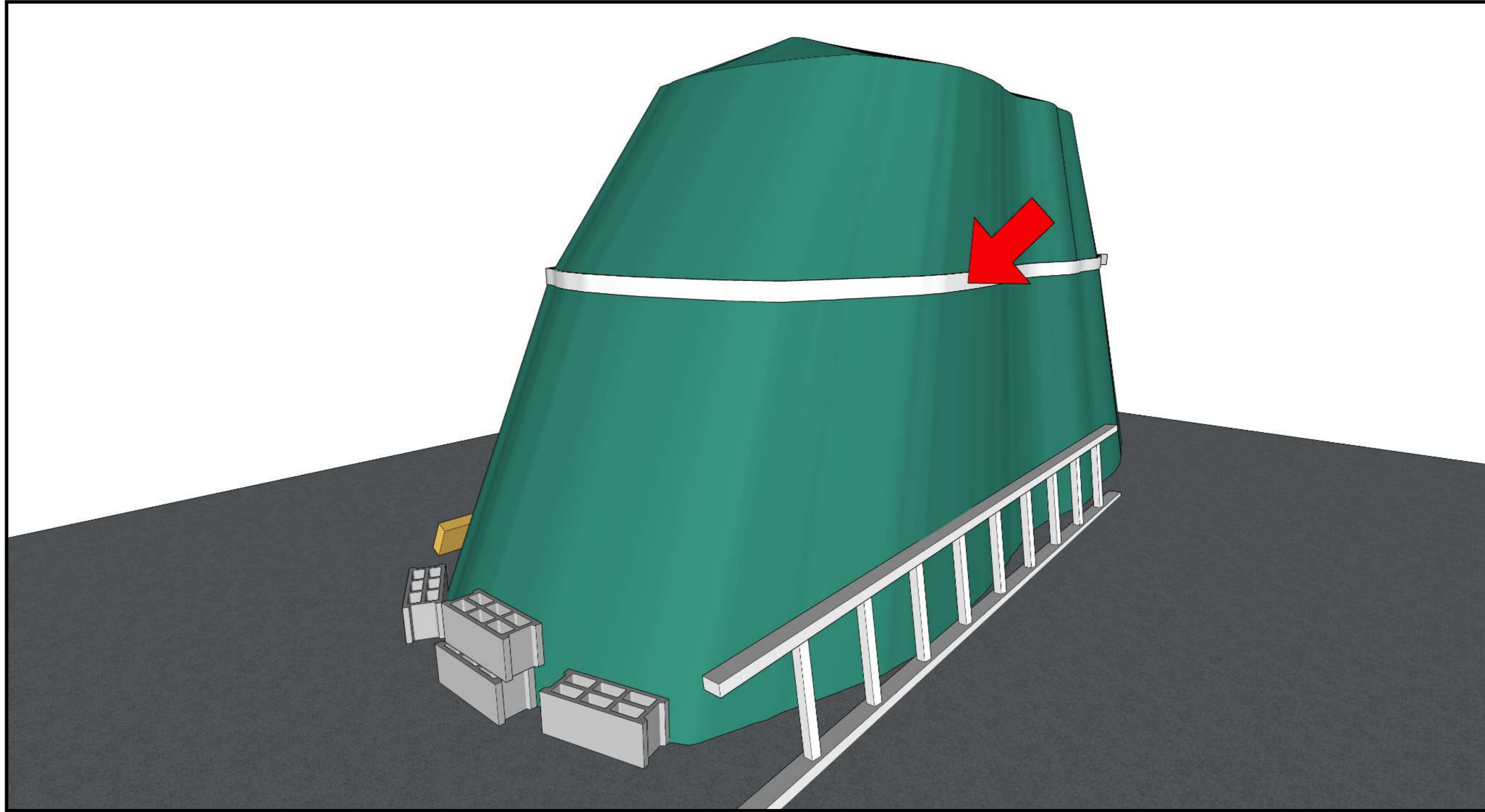

Use a heavy duty tarpaulin. Fix it with battens or straps to prevent it from tearing in the wind. Beware of condensation under the tarpaulin.



# Temporary Storage in a Storage Building

01

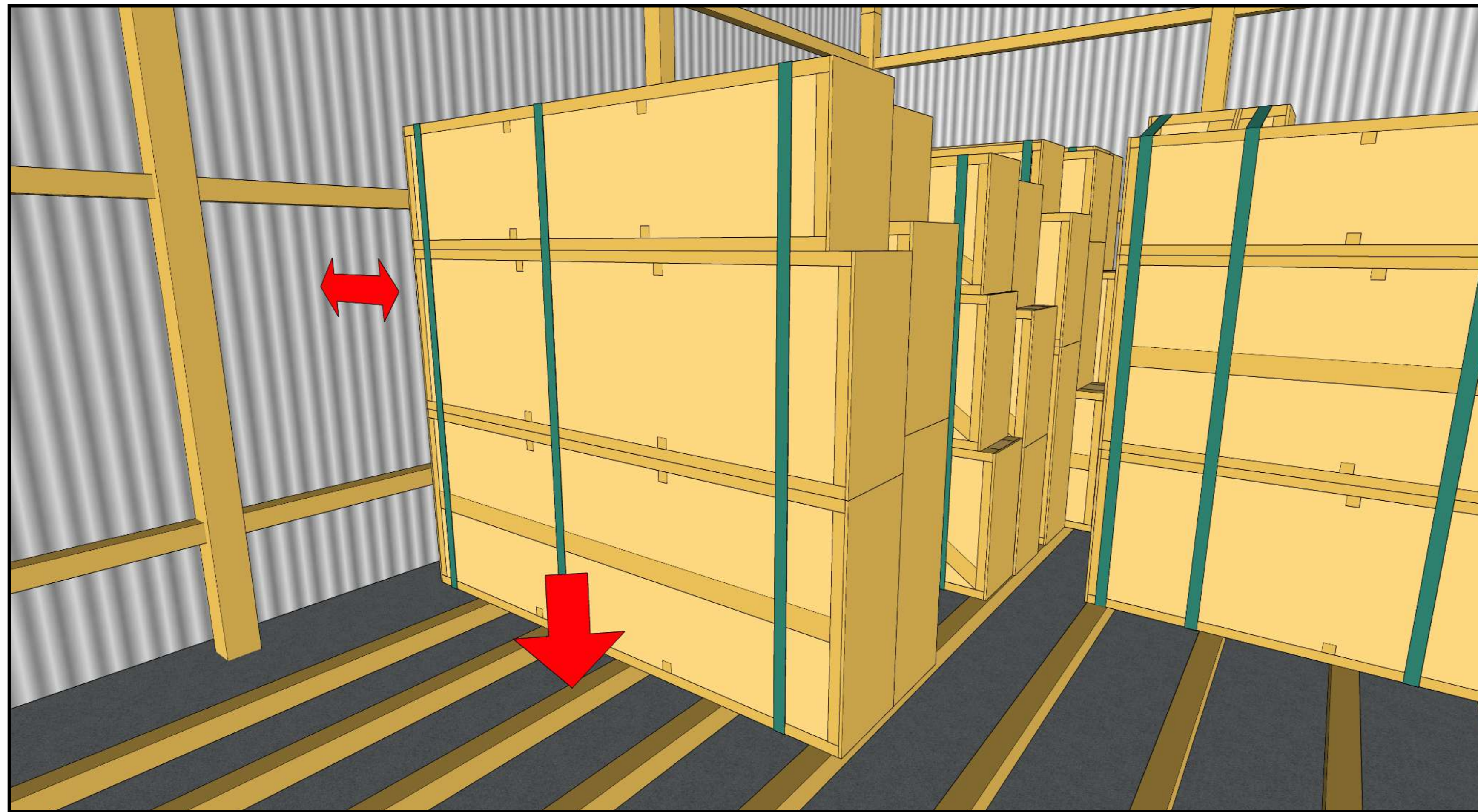

If stored in a storage building, the panels need to be kept above the ground and ventilated.

02

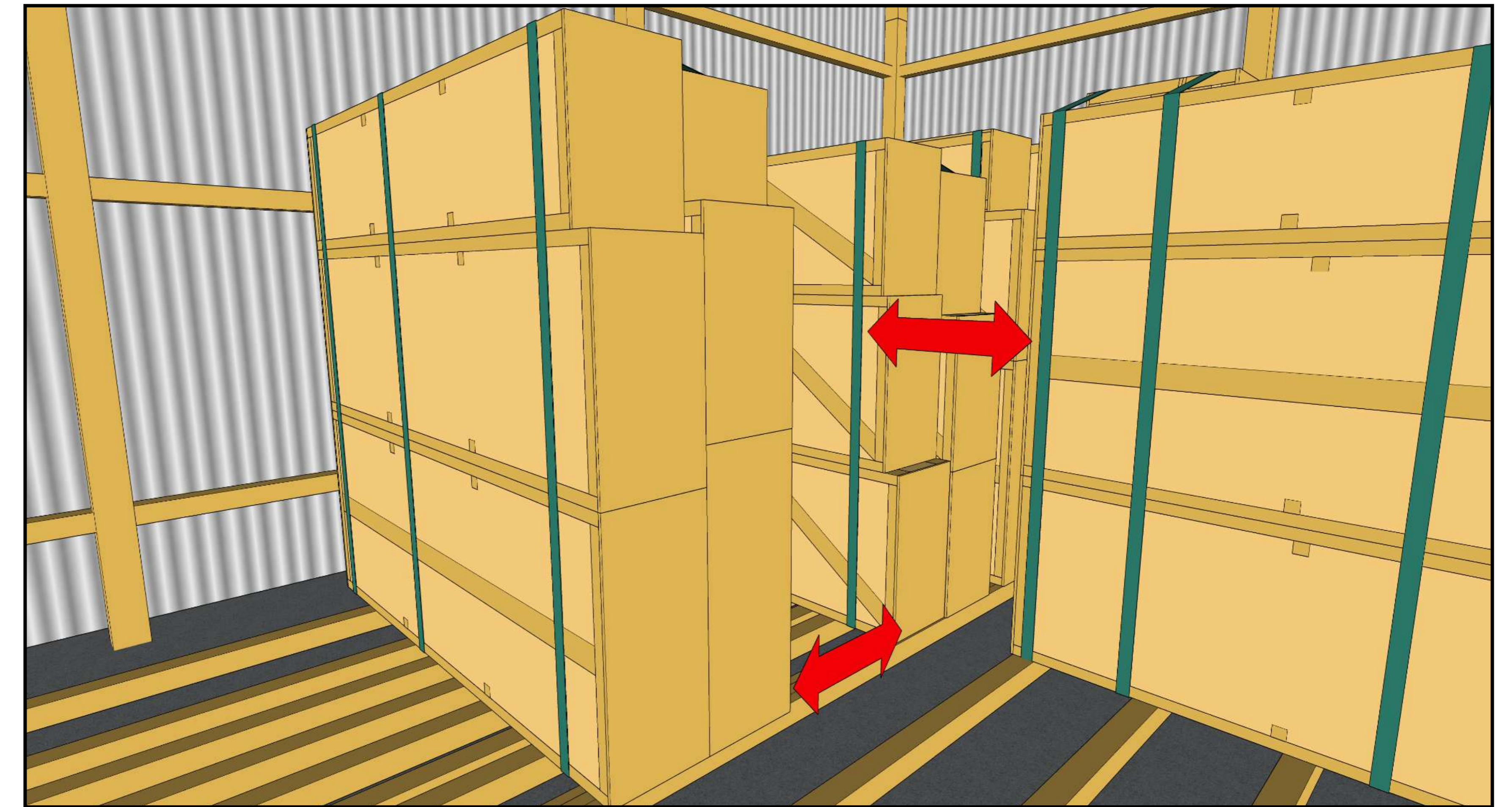

Store panels in packages with gaps between them.



# Preparing the Base Plate

01

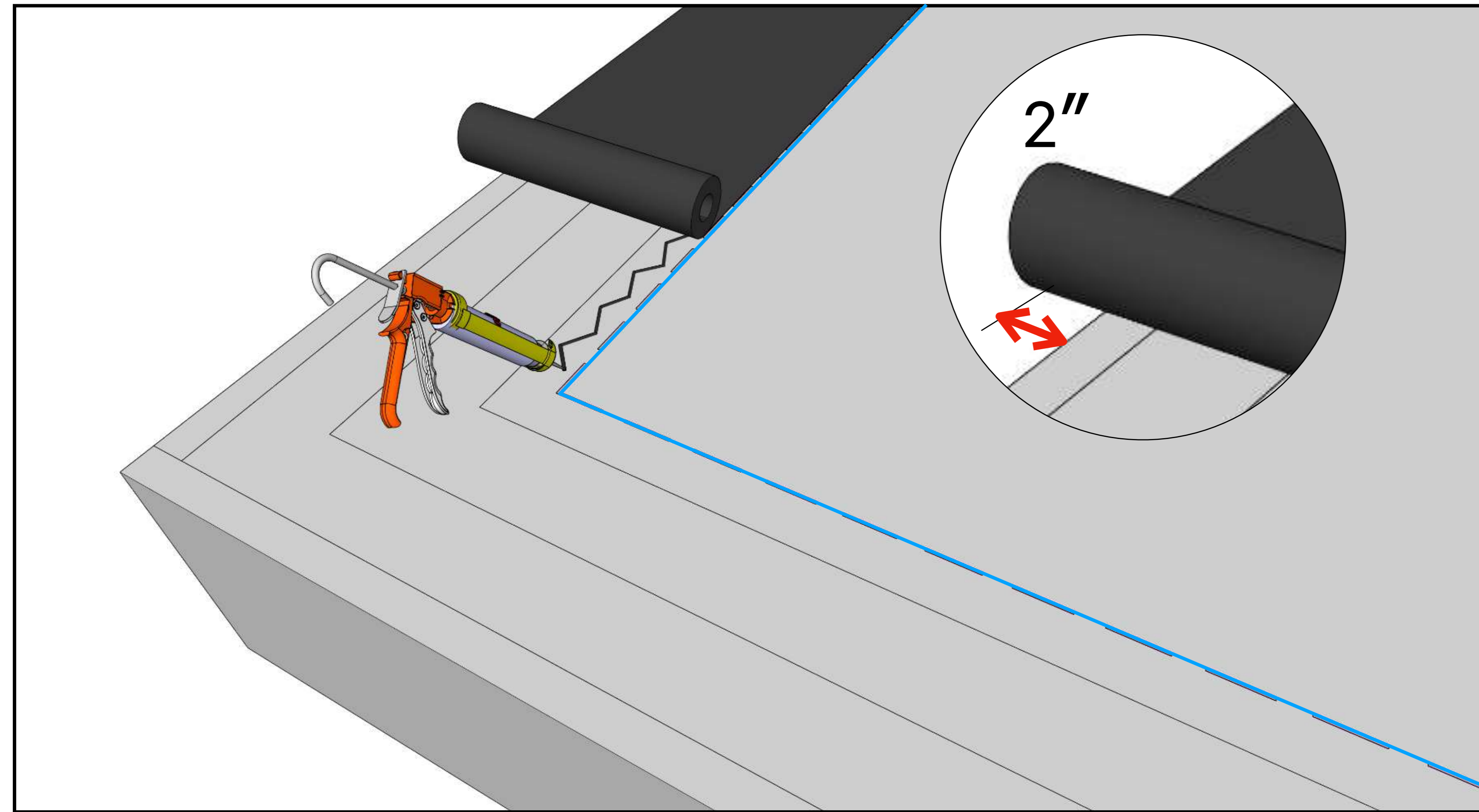

Install a waterproof membrane prior to mounting the base plate, membrane to be 2 inches wider than base plate on outer side to connect to the airtight layers later.

02

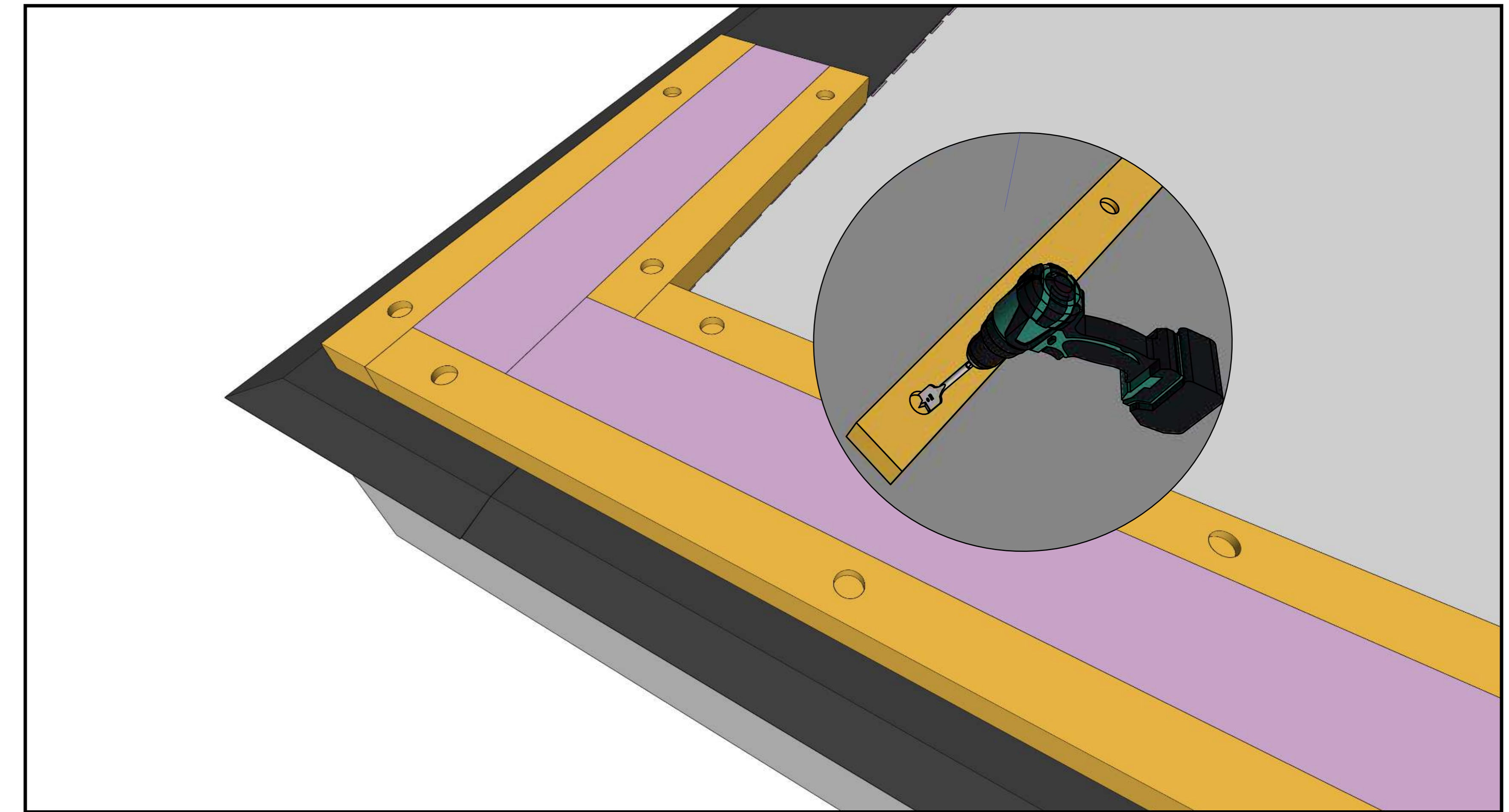

Timber base plate should match the width of the panels, and include water-resistant insulation centrally. Countersink for screws/anchors.

03

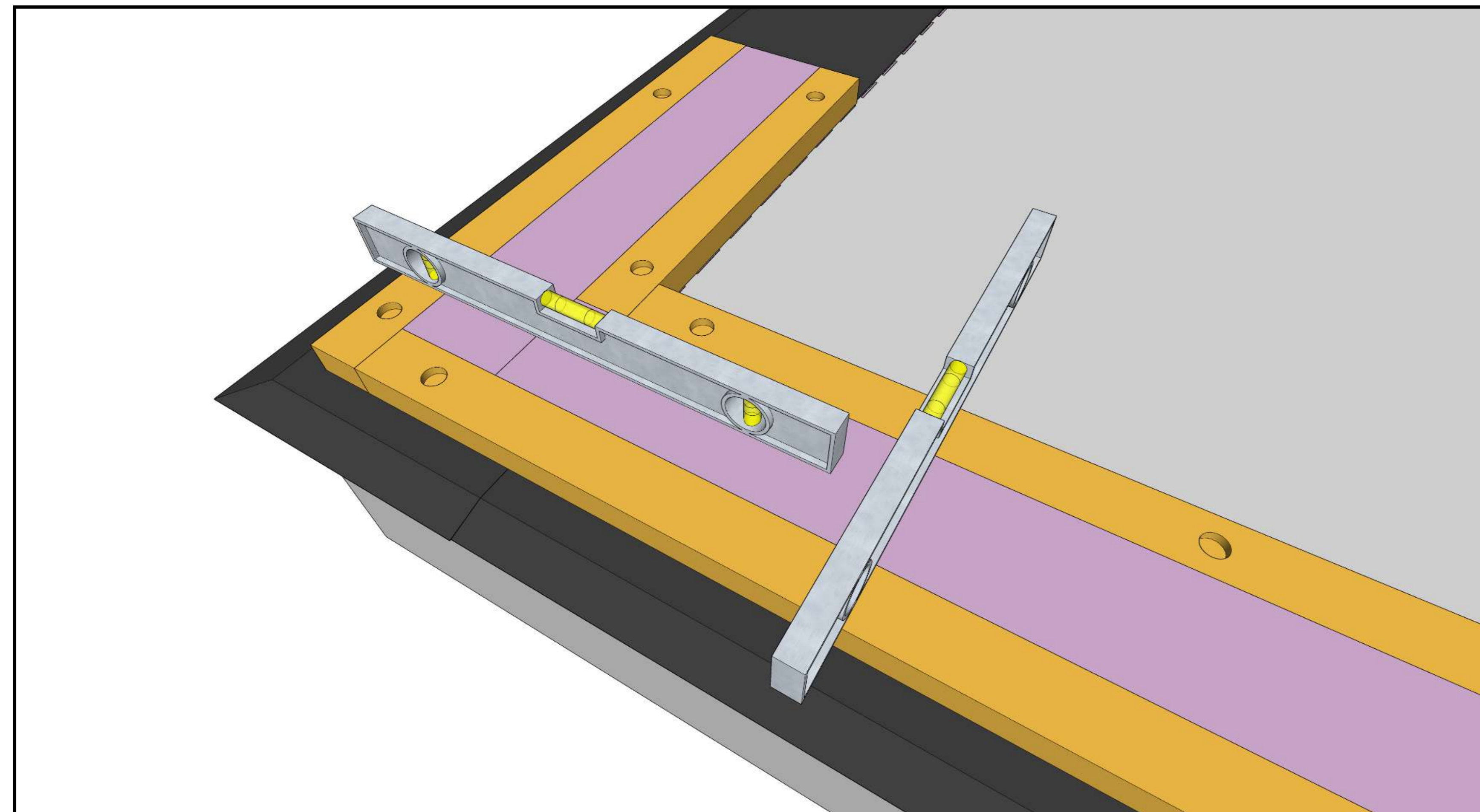

Ensure horizontal flatness of base plate. If the differences are small ( $1/16$  to  $3/16$  inches) use a plane. If the differences are larger, level the foundation or use a custom-made base plate.

04

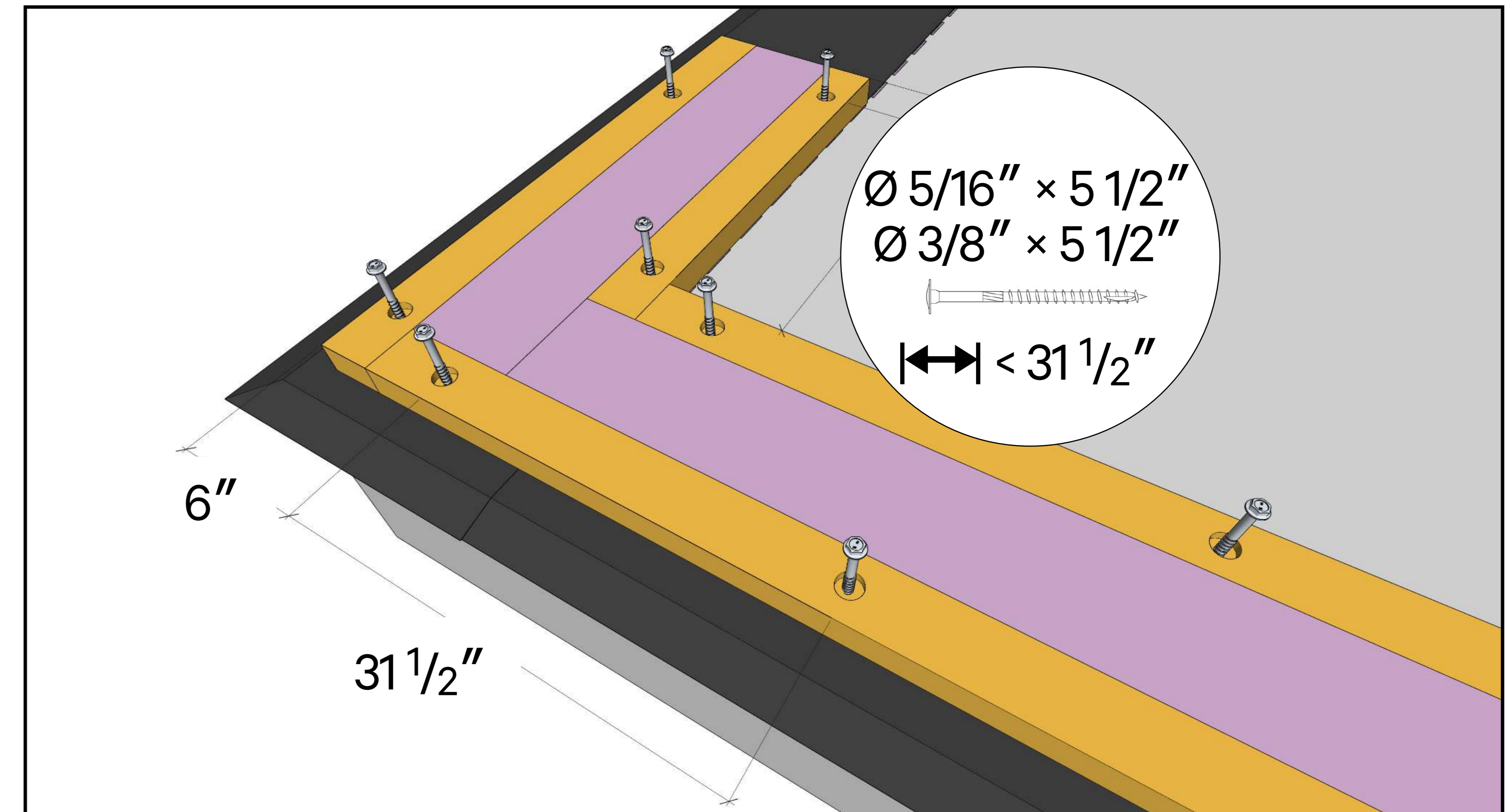

Use screws every  $31\frac{1}{2}$  inches (6 inches from corner and openings), unless indicated otherwise by the structural engineer.



# Connections to Existing Structures

01

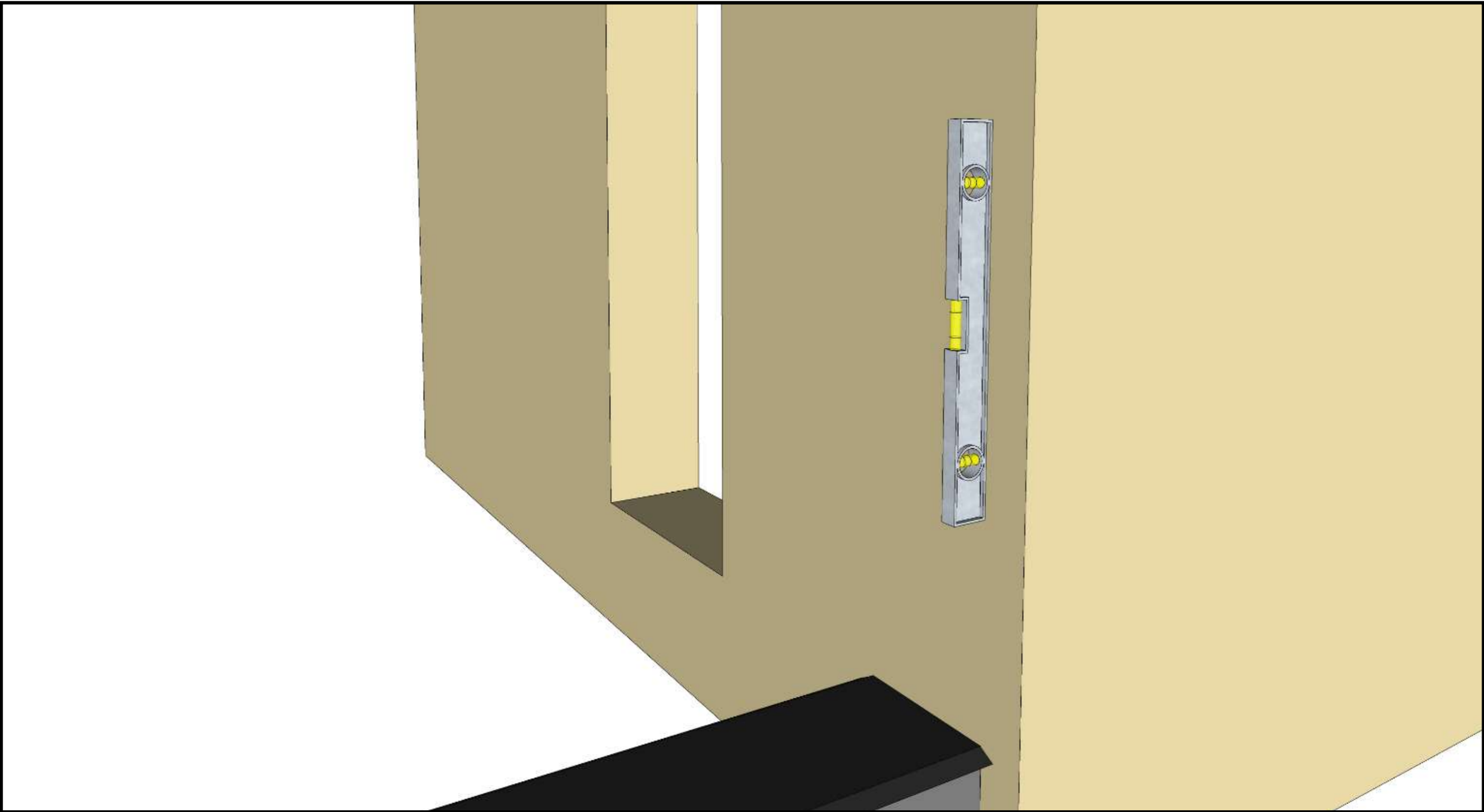

Ensure the wall surface is even.

02

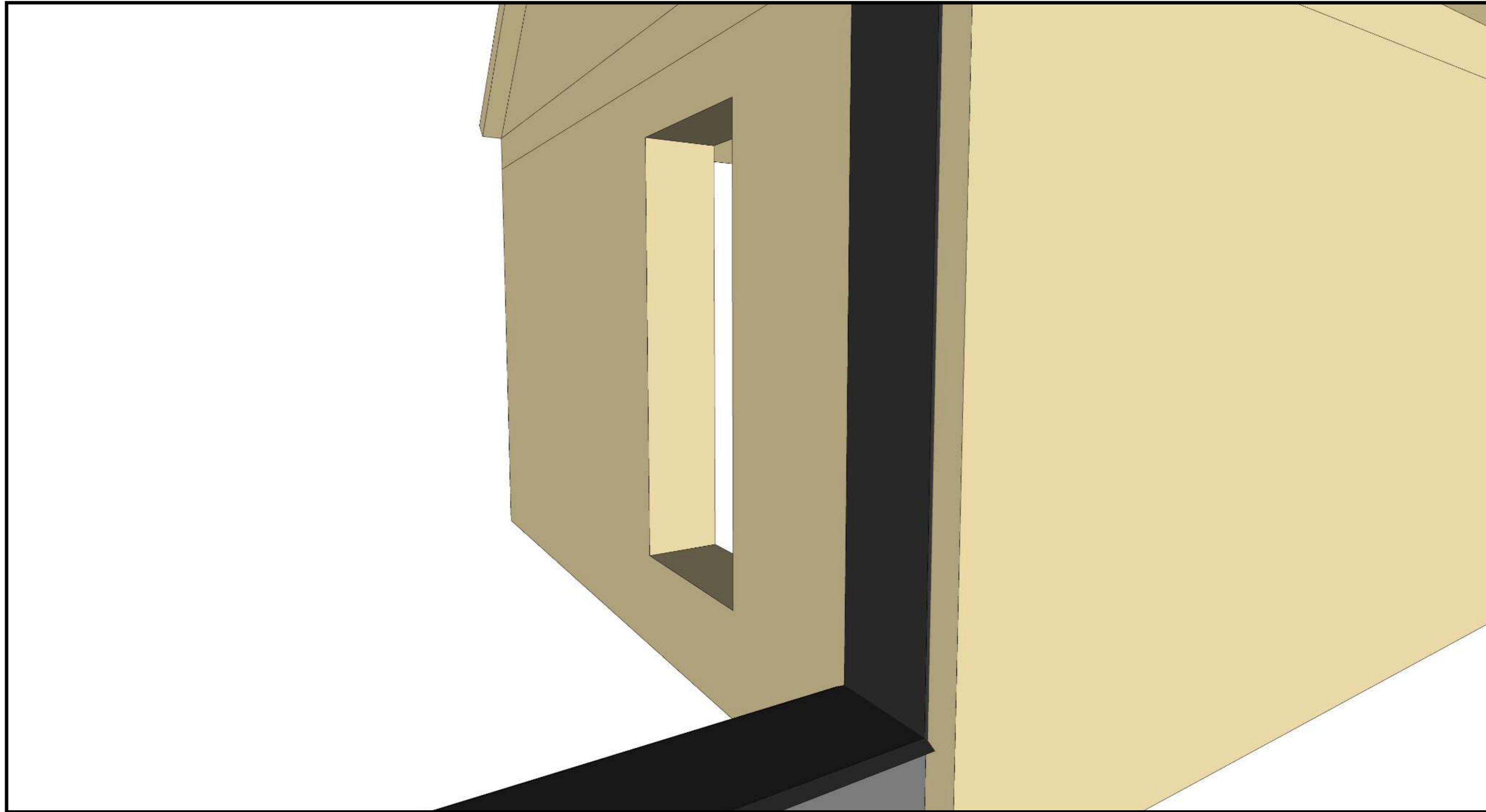

Ensure waterproofing and airtight connection in the same way as for foundations.

03

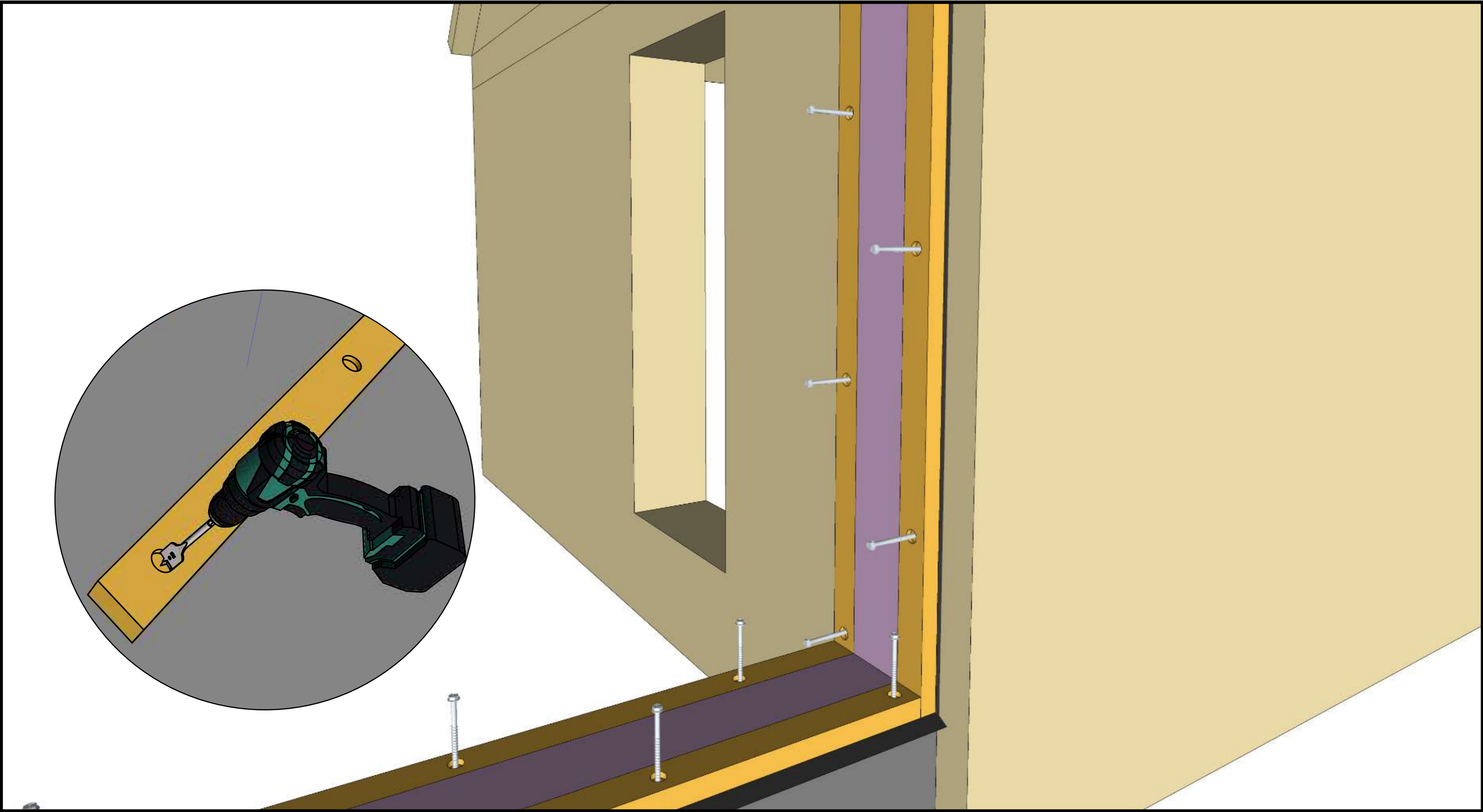

Anchor the base plate vertically to the wall in the same way as for foundations. Countersink for screws/anchors.



# Lifting the Panels

01

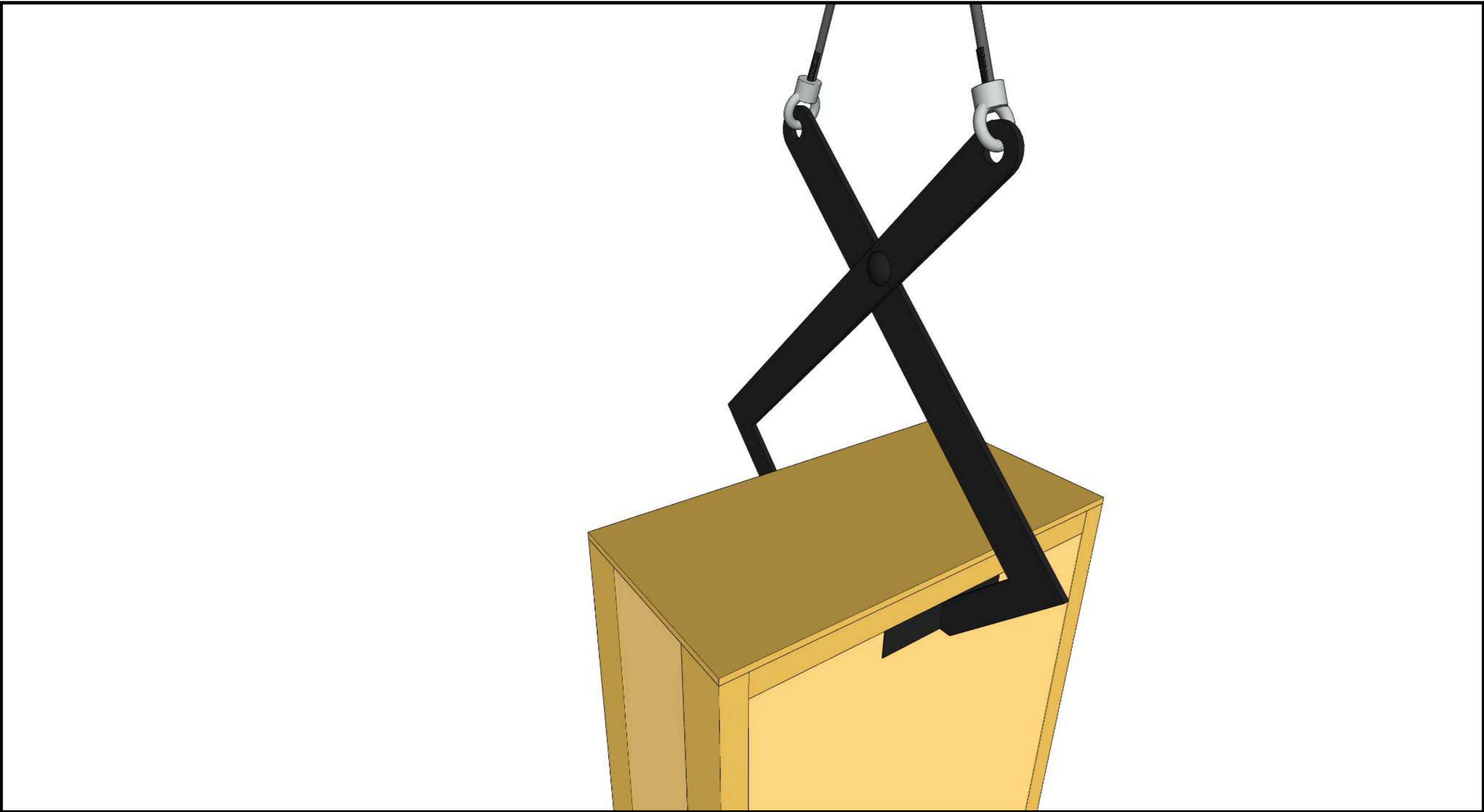

Different lifting strategies are possible: use a clamping tool.

02

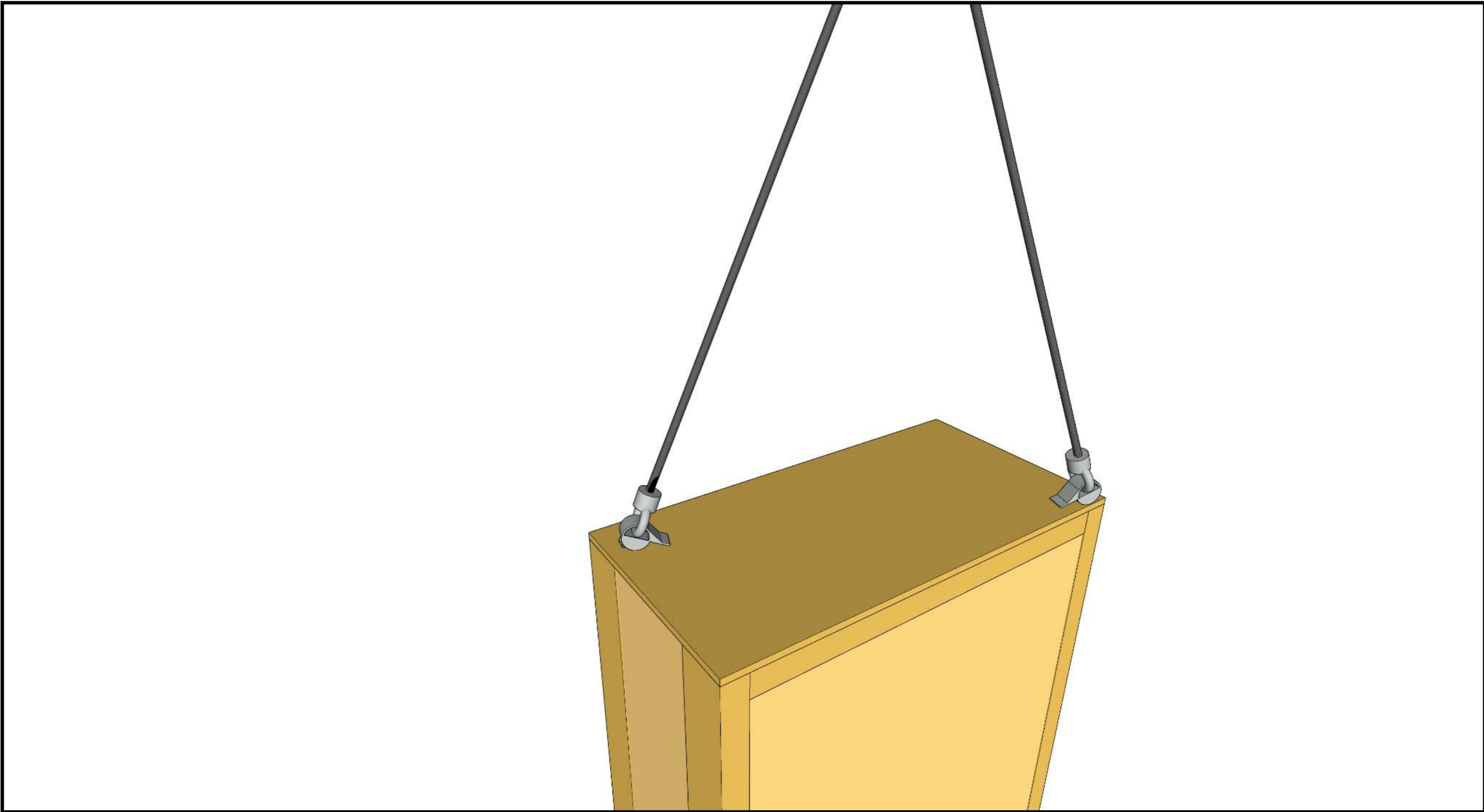

Temporarily fix anchors in two diagonal corners.

03

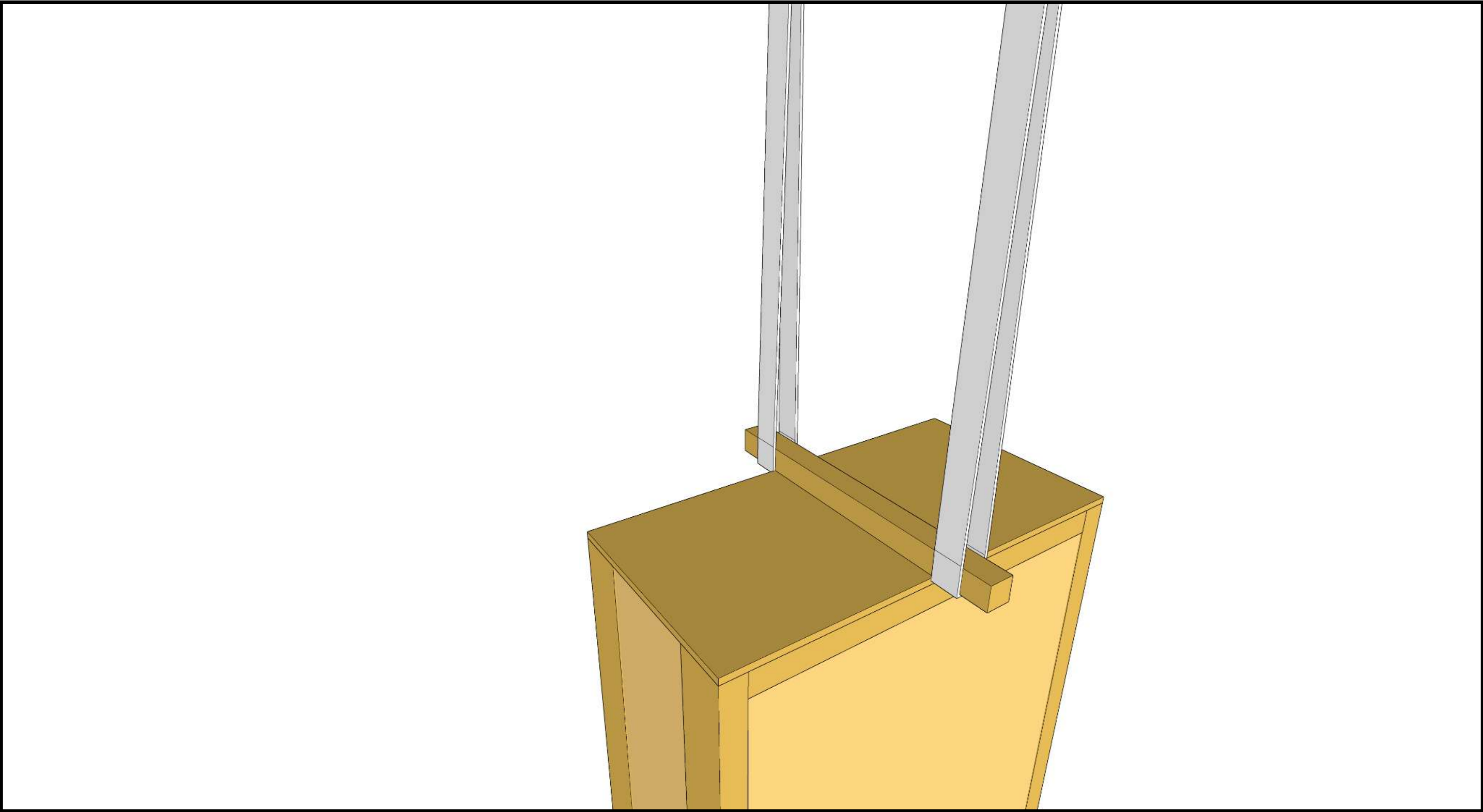

Screw a strong timber across in the middle.

04

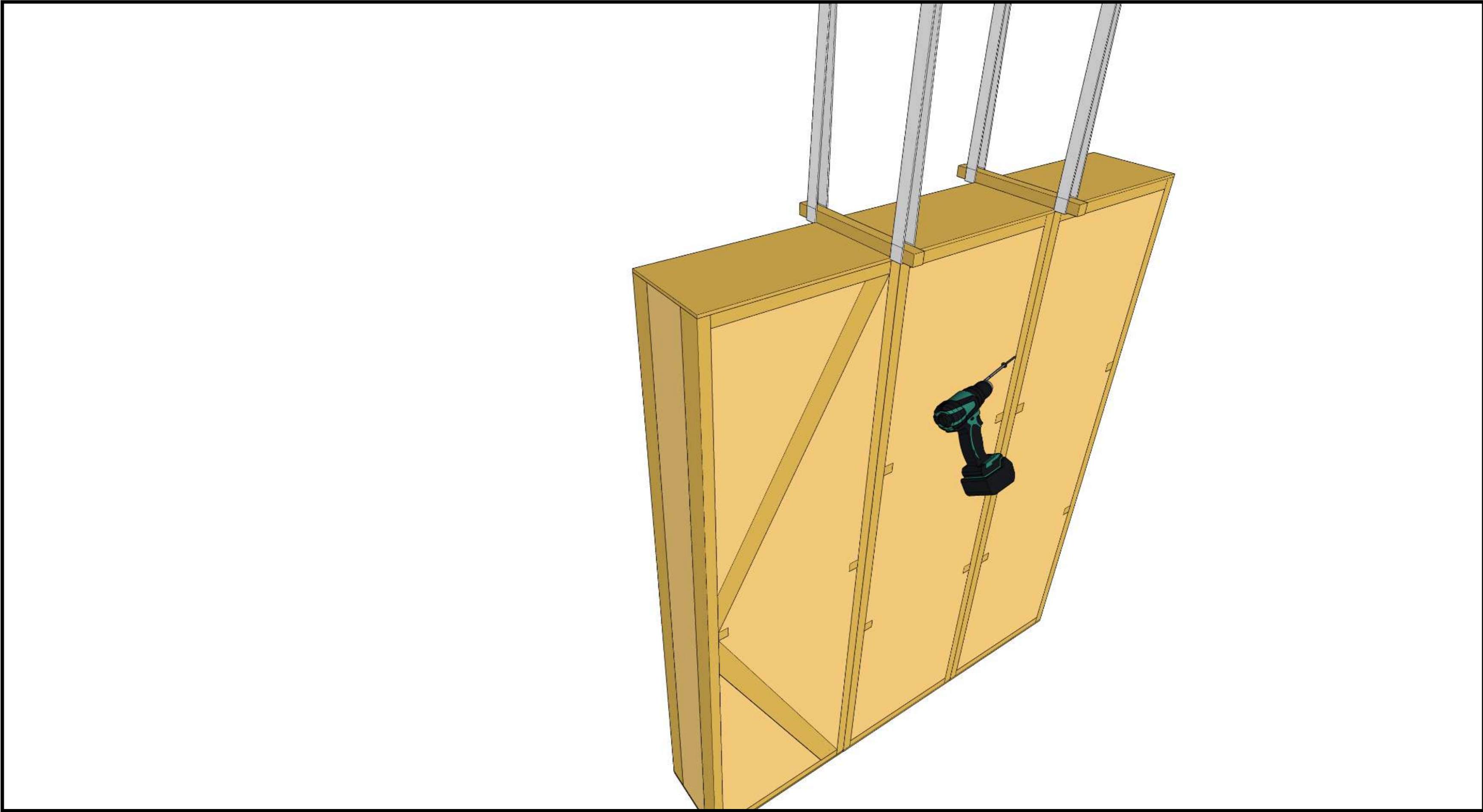

It is possible to pre-assemble multiple panels before lifting them to a higher floor. Ensure the lift's capacity matches the weight.



# Panel Assembly

01

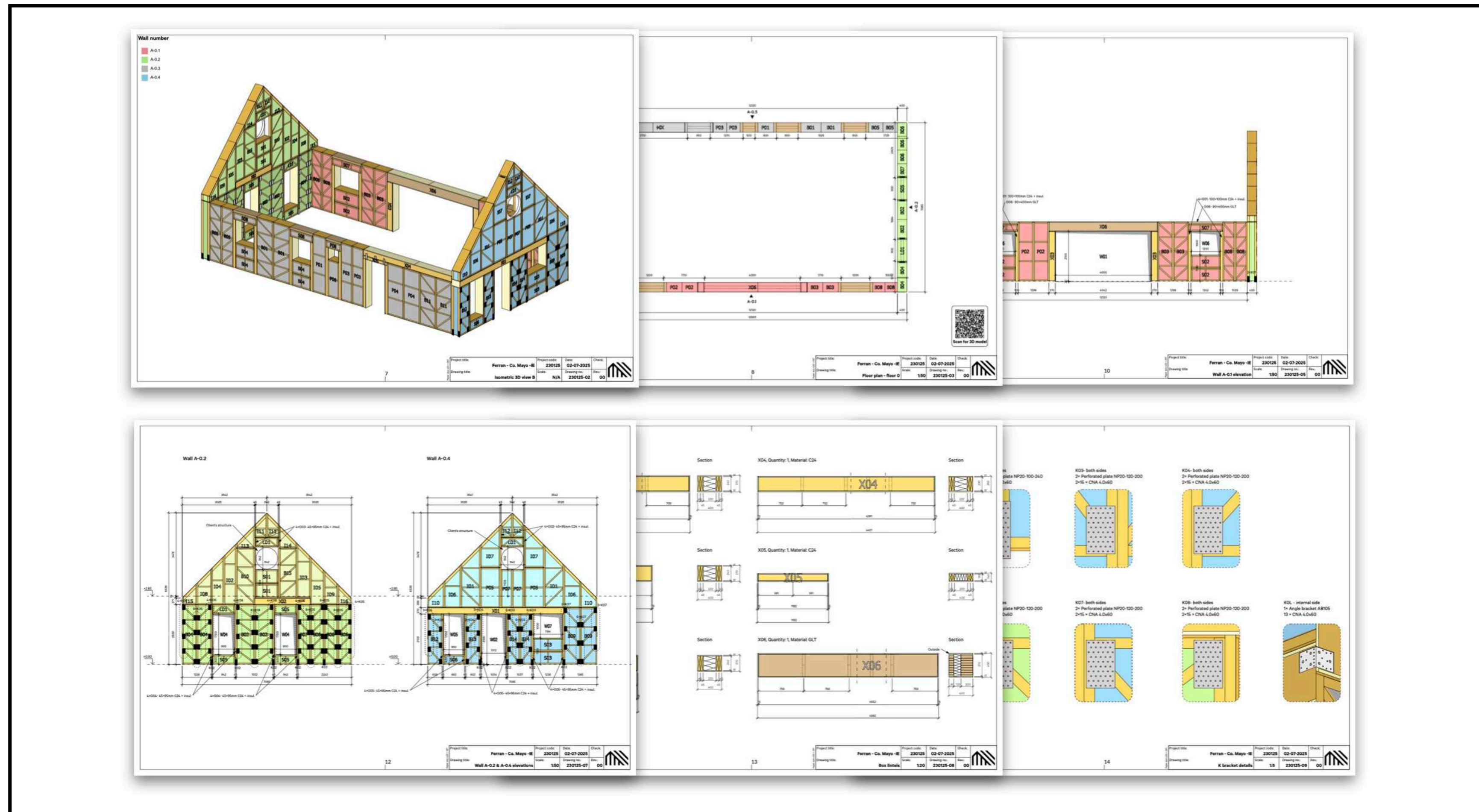

Use the Panel Project as the panel layout plan during on-site assembly.

02

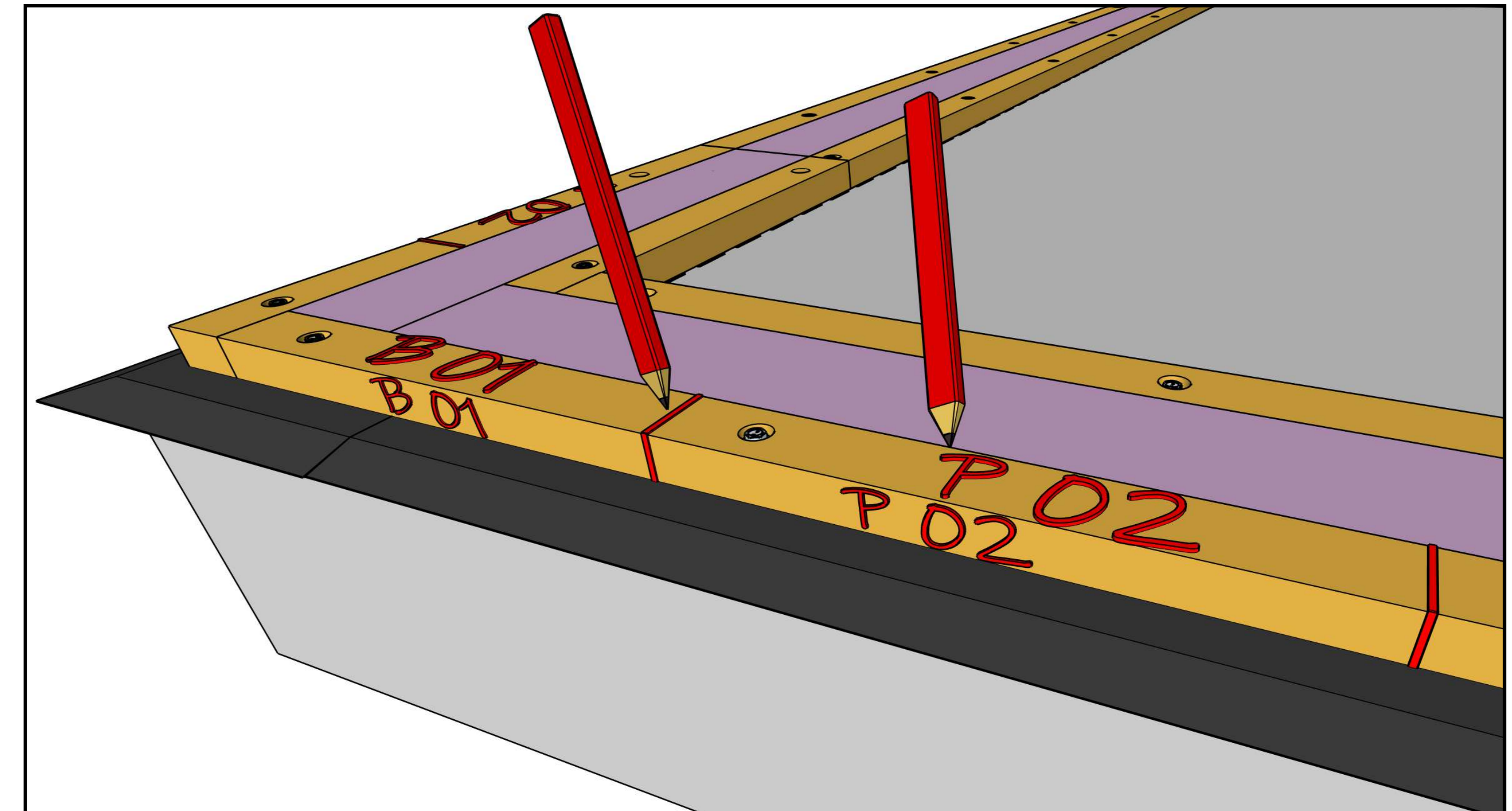

Mark panel positions on the base plate's top and side, and write the panel number.

03

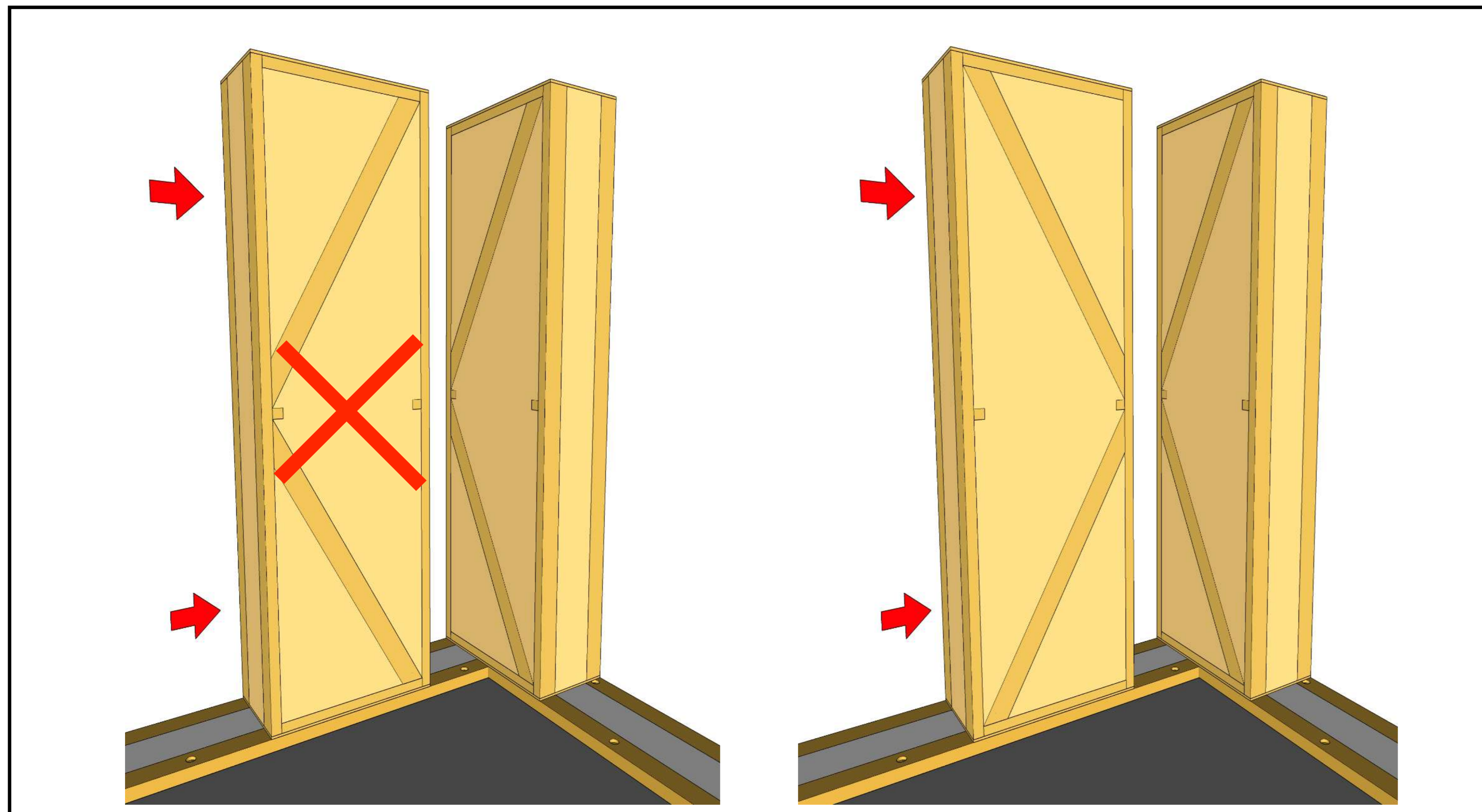

Start with two corner panels. Make sure the braced panels are placed in the correct orientation.

04

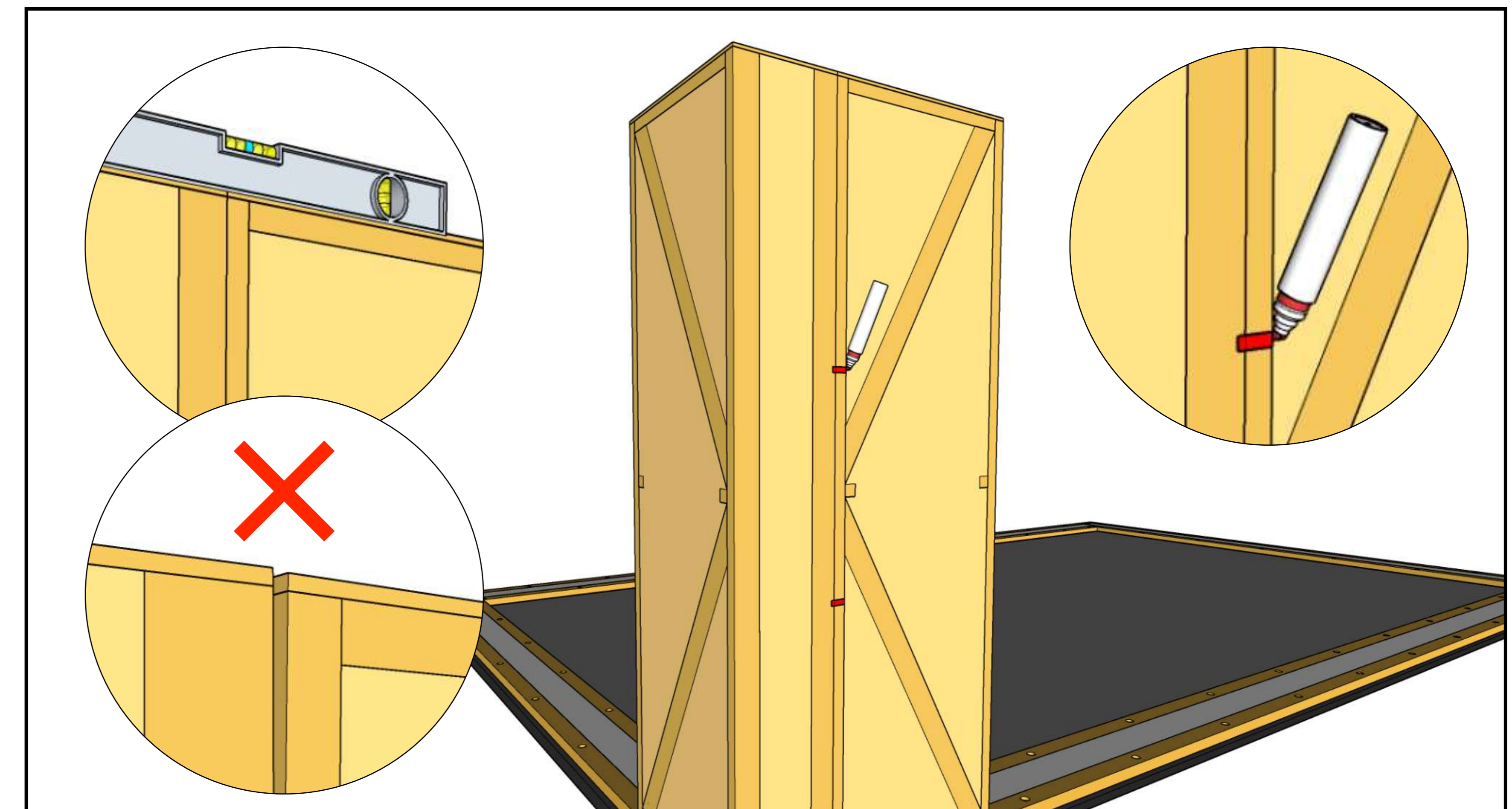

Mark the position of screws according to the scheme (p. 21). Check if the tops of the panels are level before screwing.



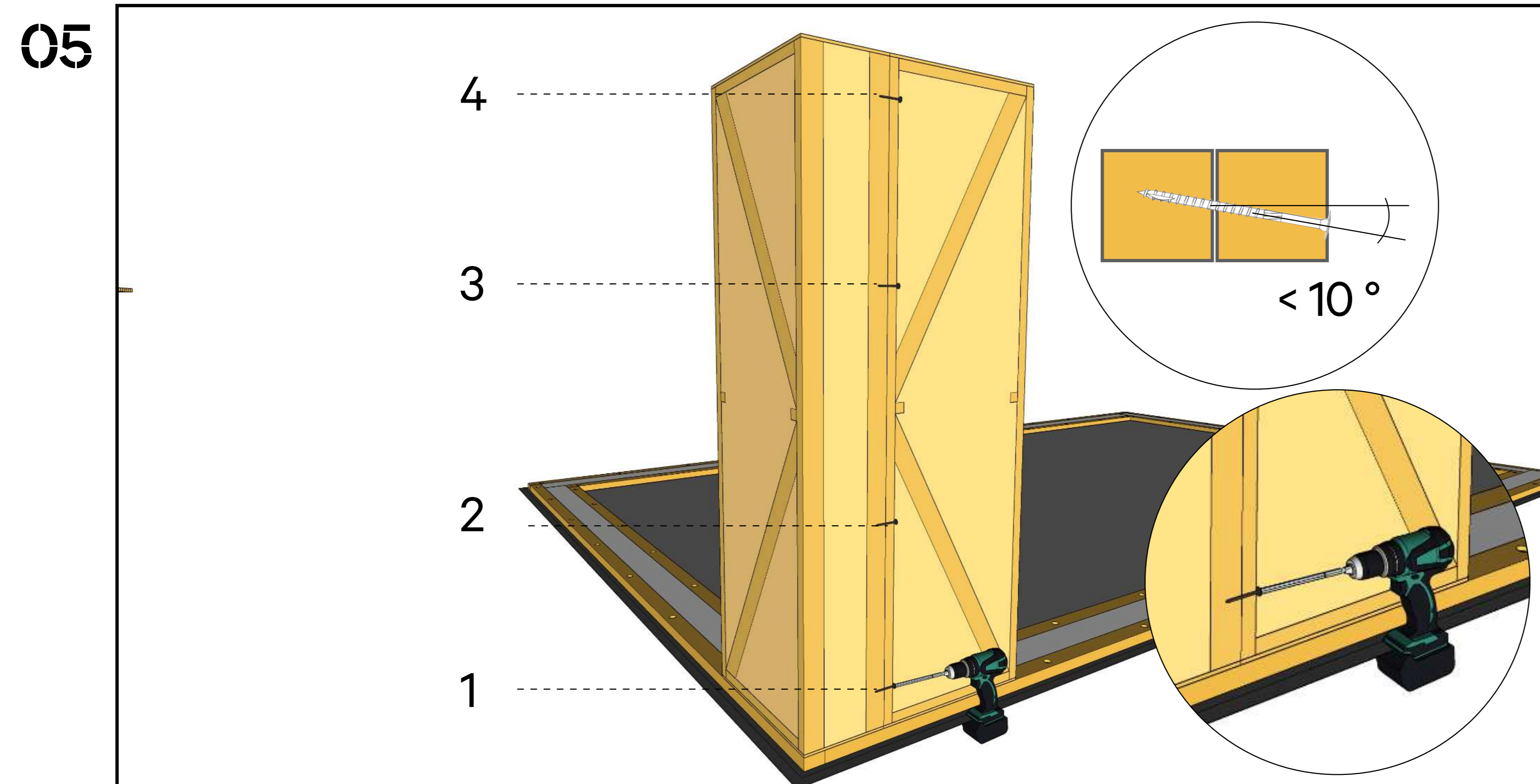

Screw panels together from the bottom up on the outside. Insert screws as perpendicular as possible, within a 10° maximum deviation.



Do not screw to the base plate yet.

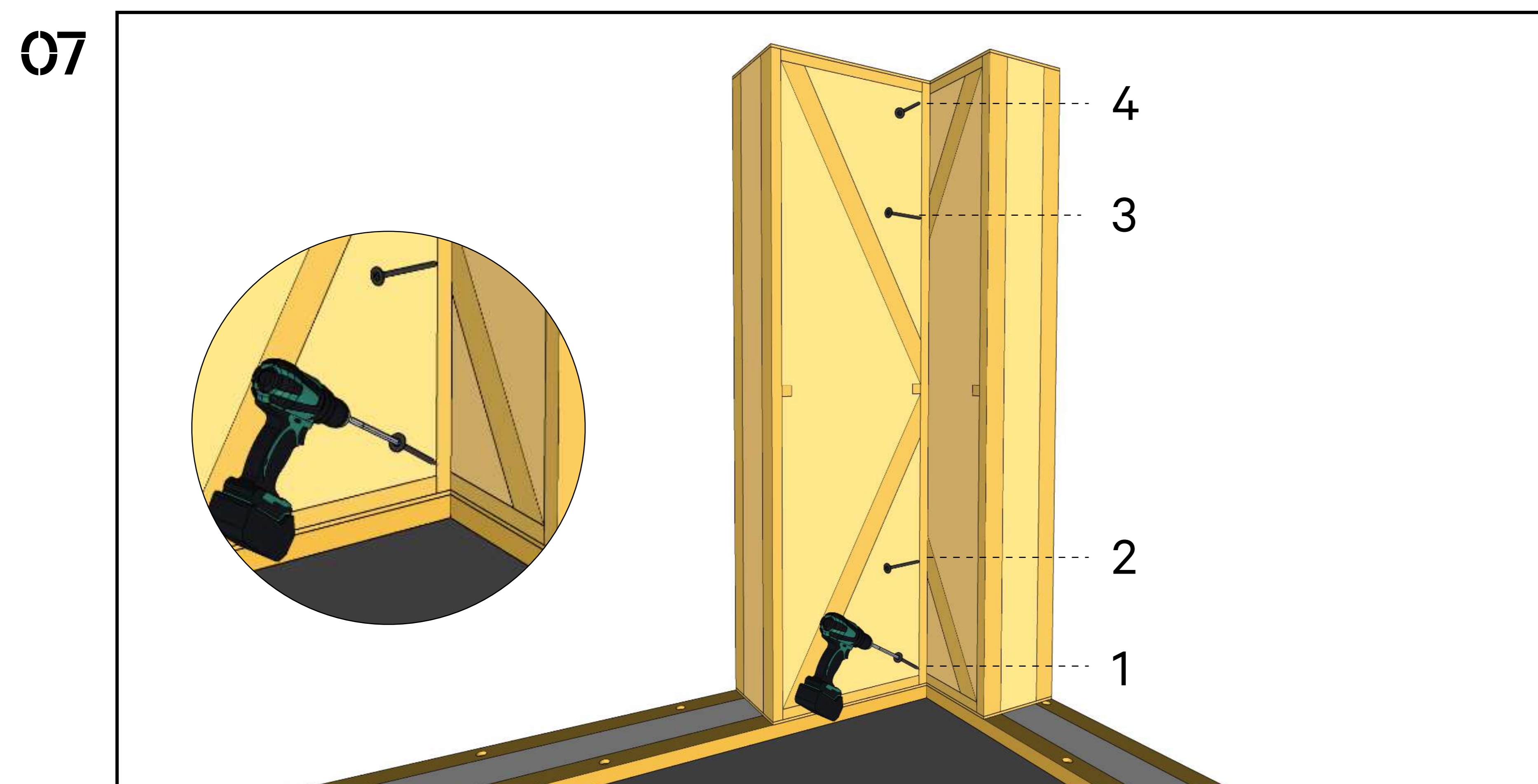

Do the same on the inside, but screw the inside corners diagonally. Do not screw to the base plate.

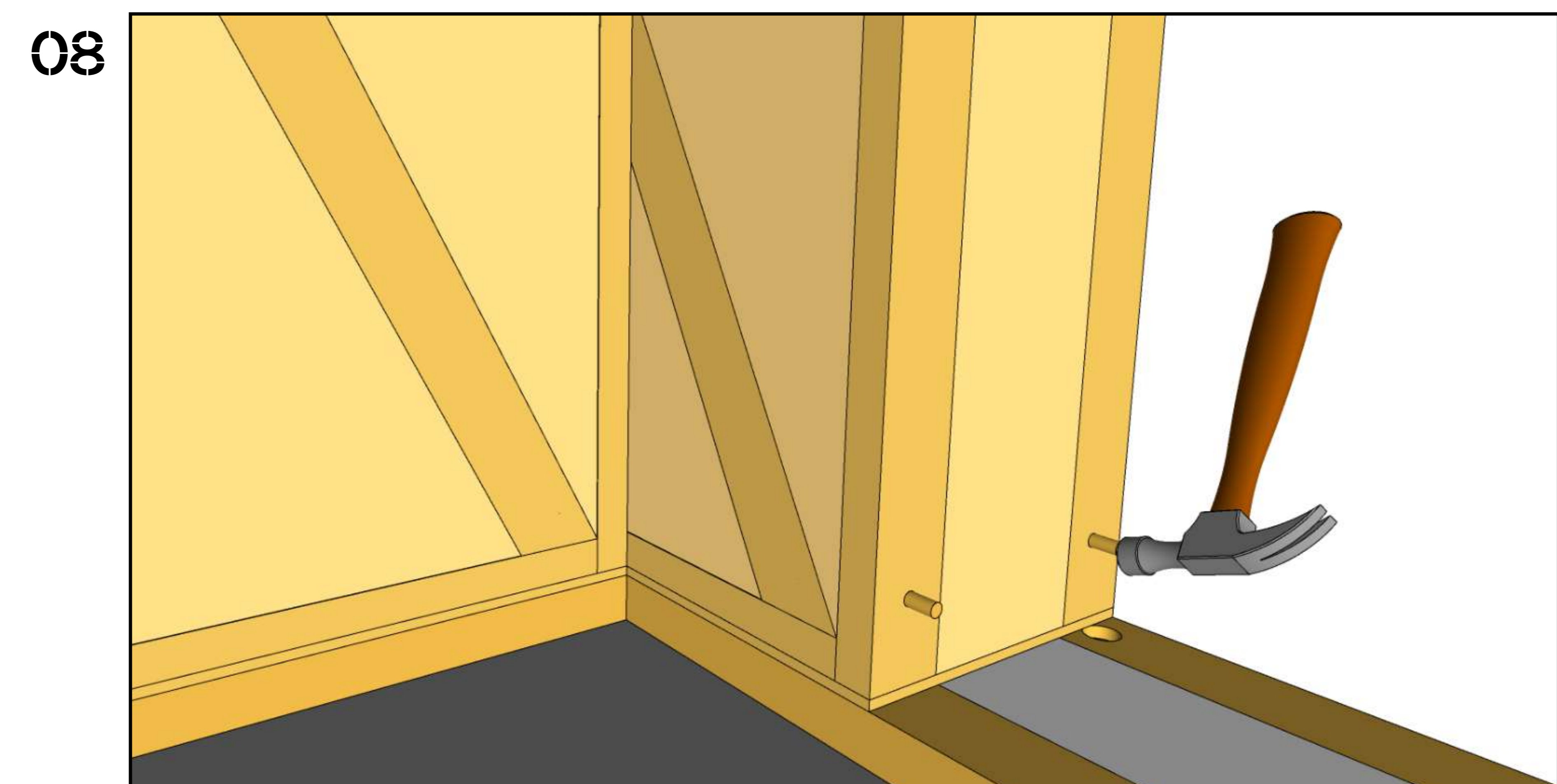

Insert the dowels into the holes to ensure exact connection.

09

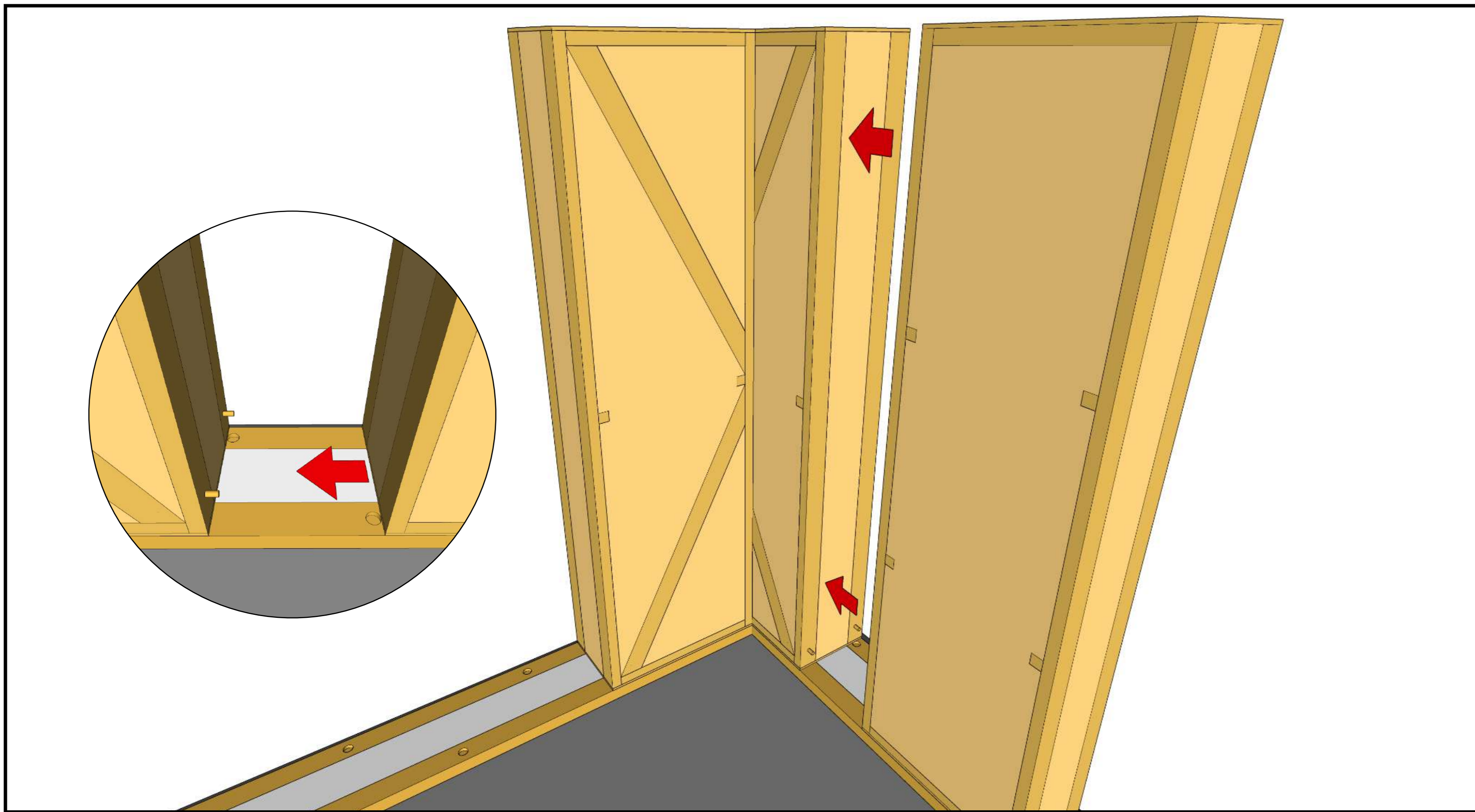

Push the next panel onto the corner panel.

10

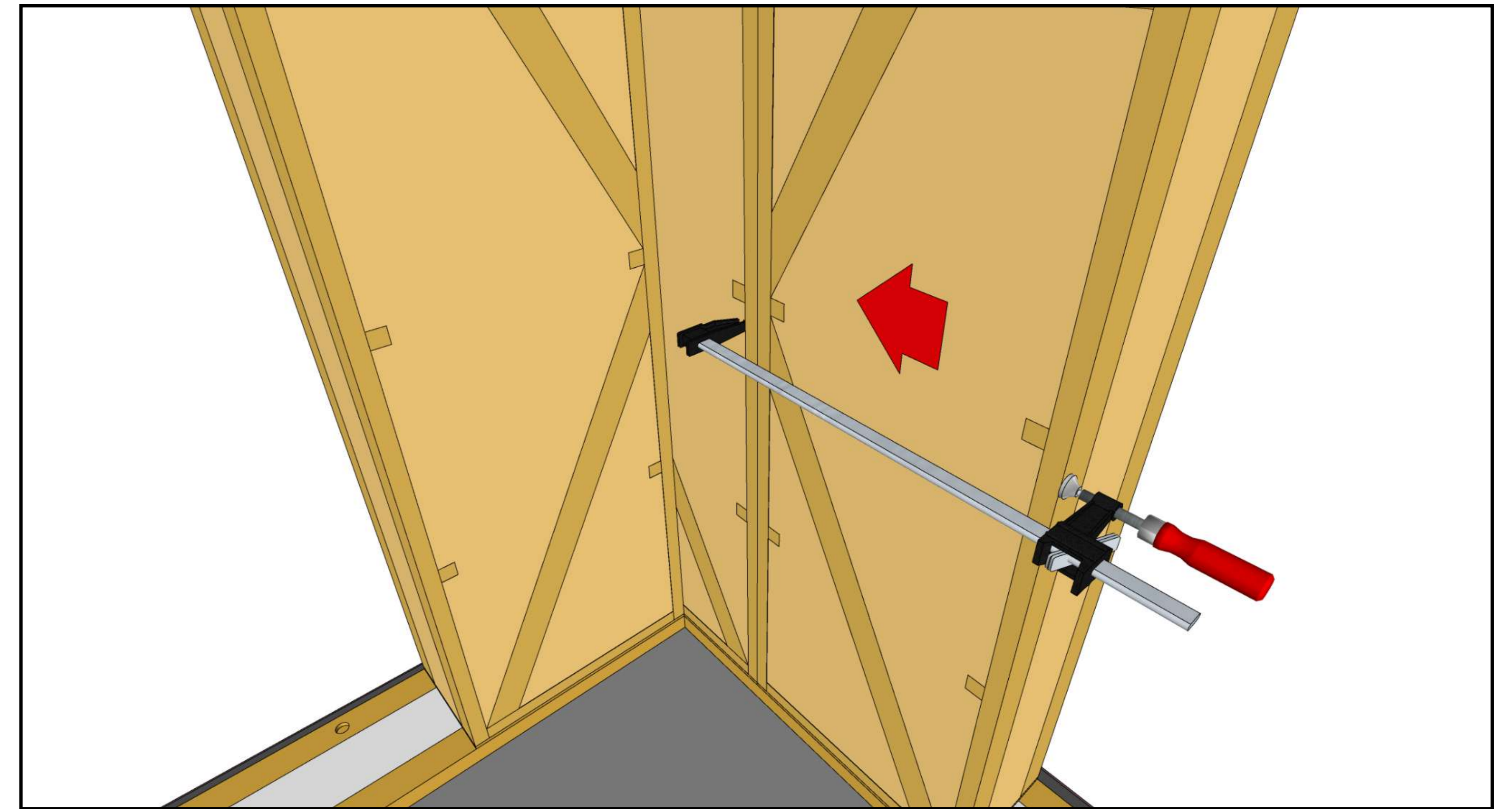

If necessary, use clamps to compress panels together.

11

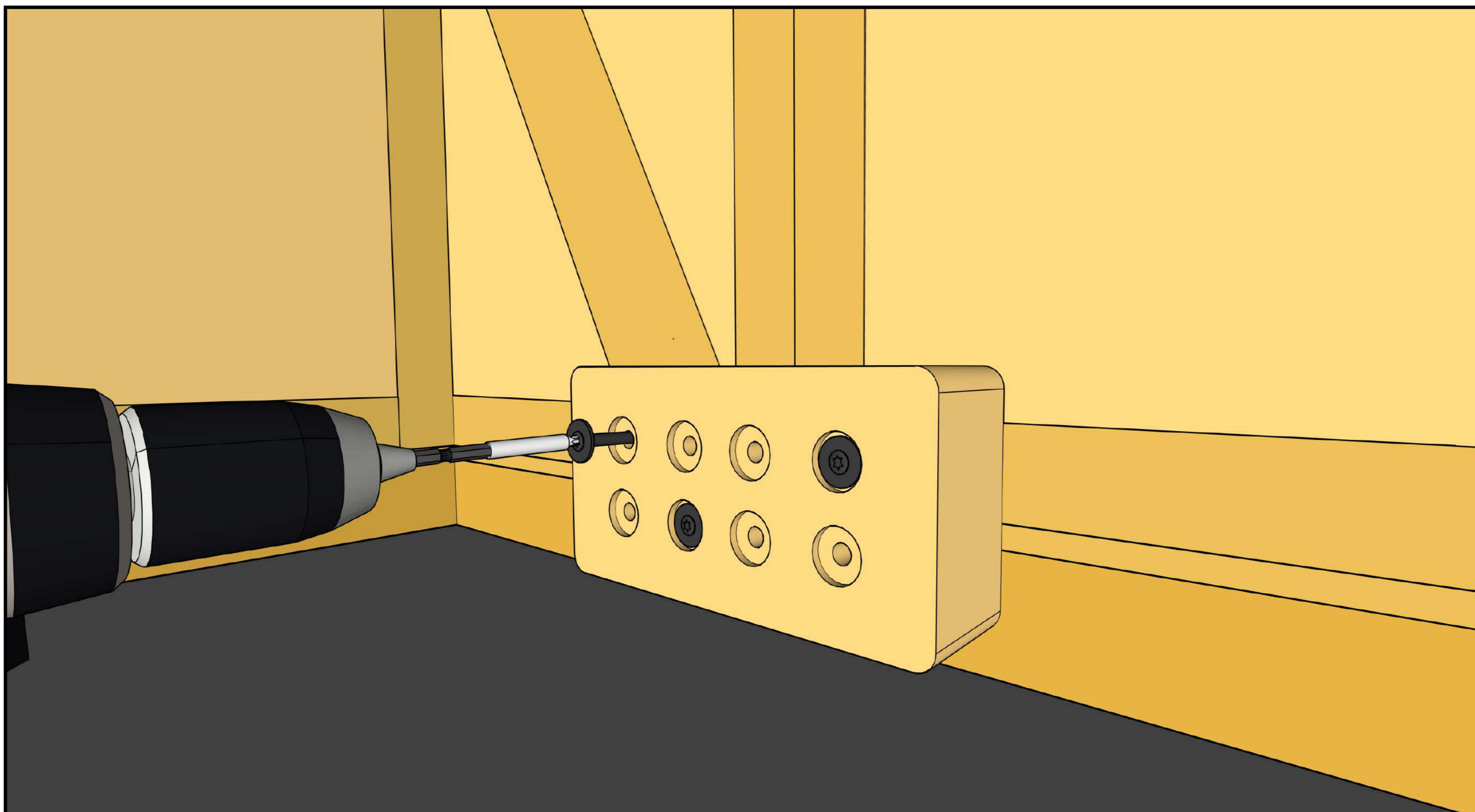

Temporarily screw a piece of wood to the studs to level the panels.

12

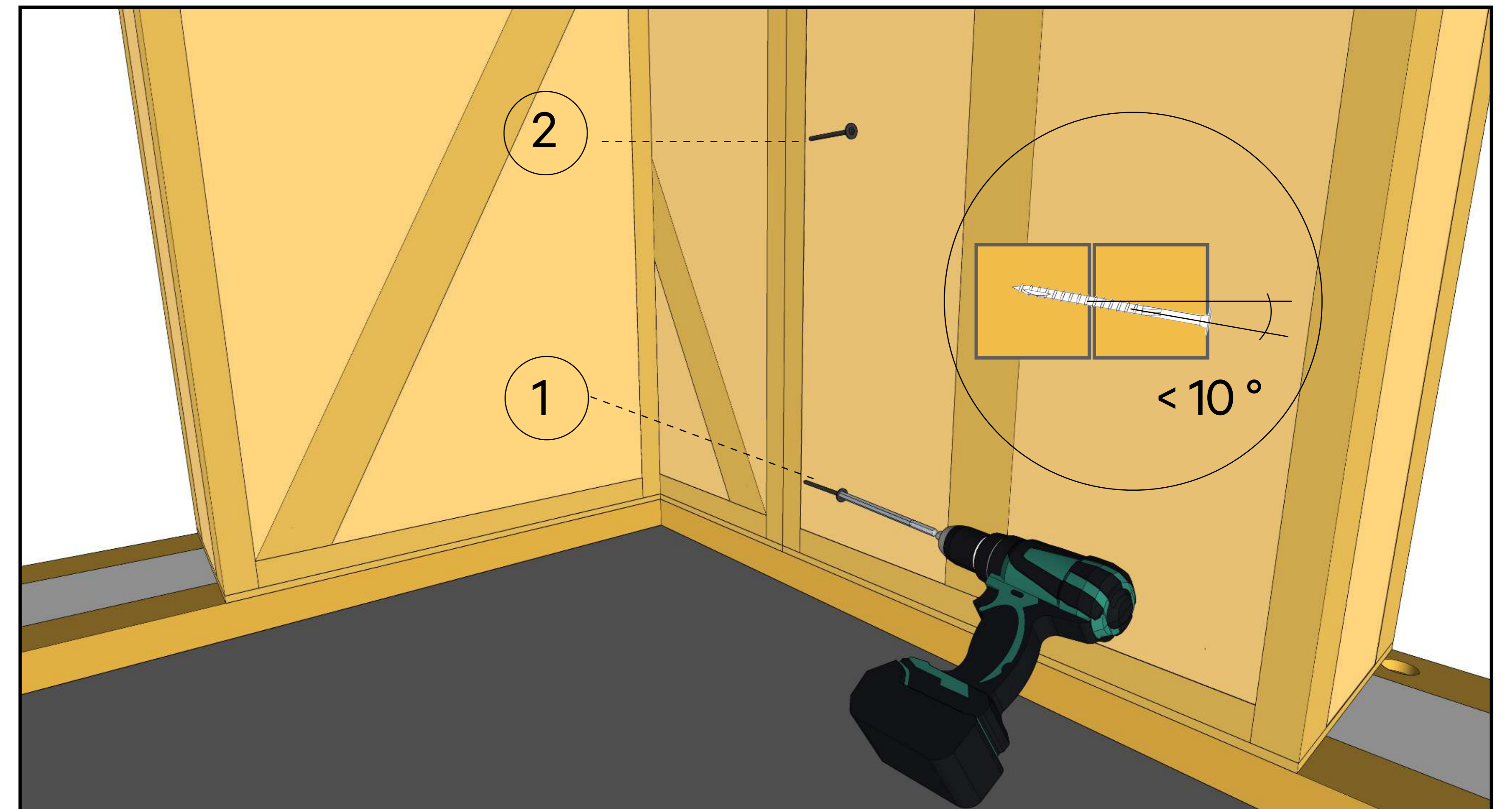

Screw the panels together from the bottom up on the inside. Insert screws as perpendicular as possible, within a  $10^\circ$  maximum deviation.



13

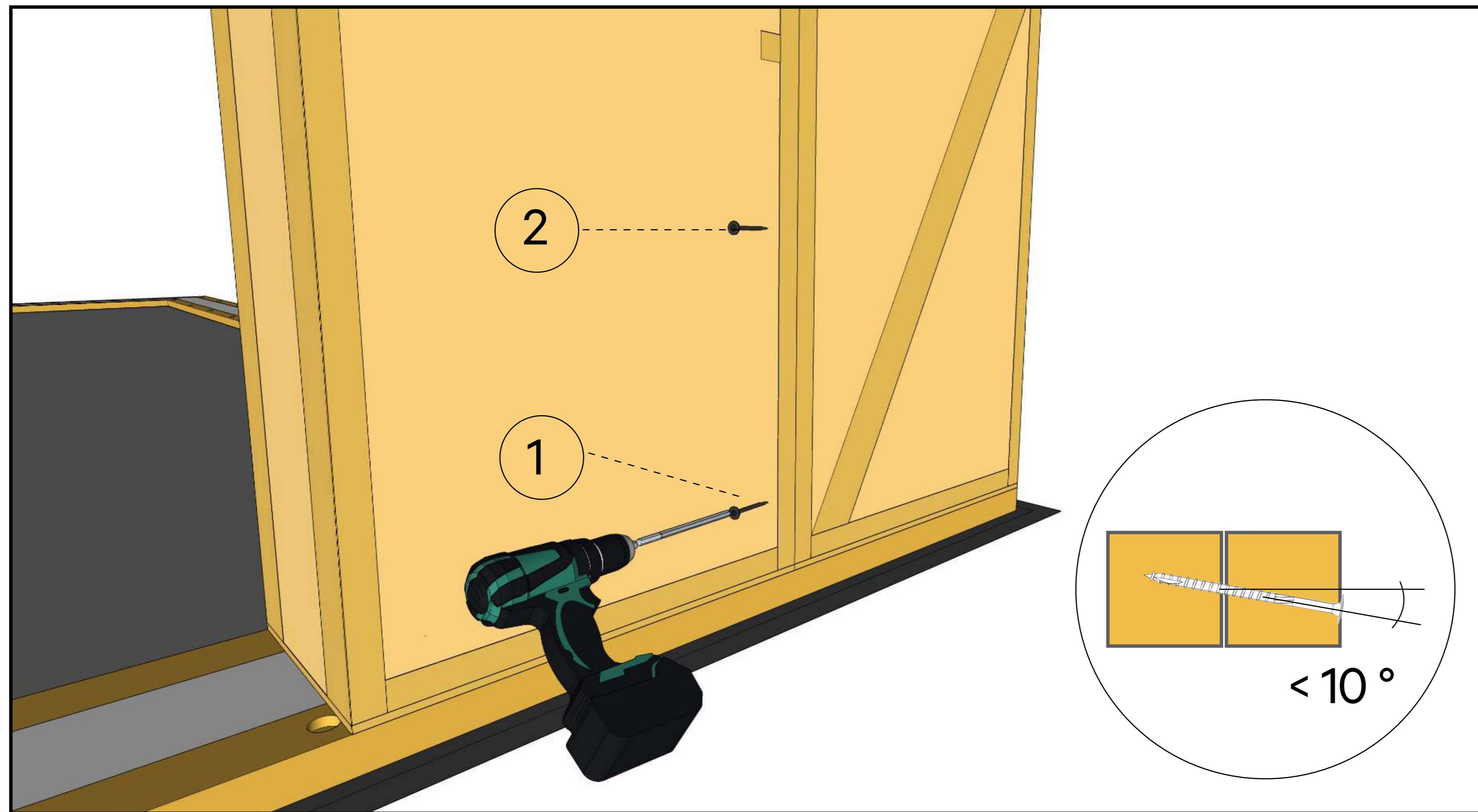

Do the same on the outside. Do not screw to the base plate yet.

14

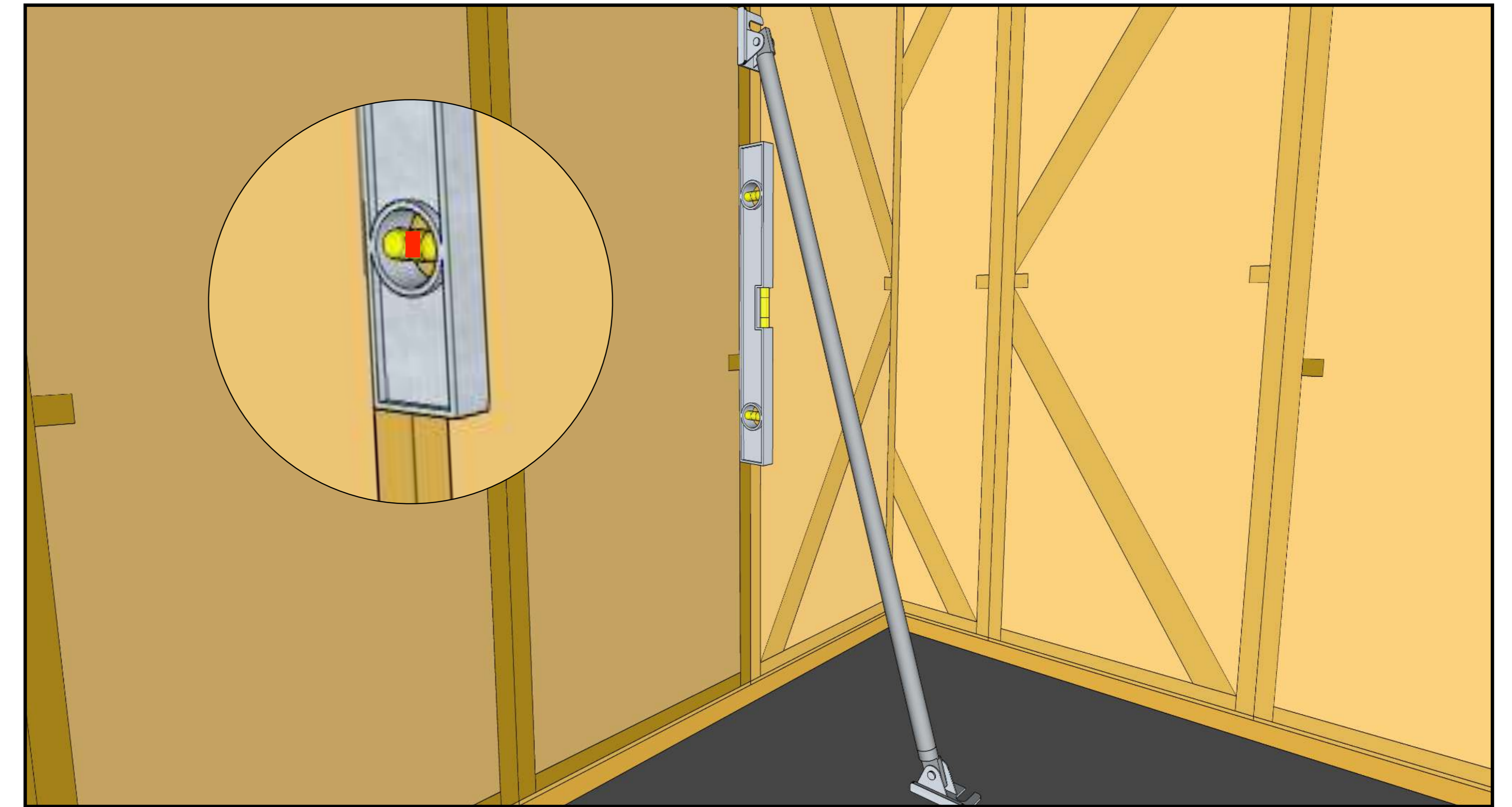

Use temporary bracing for every third panel to ensure stability of the wall.

15

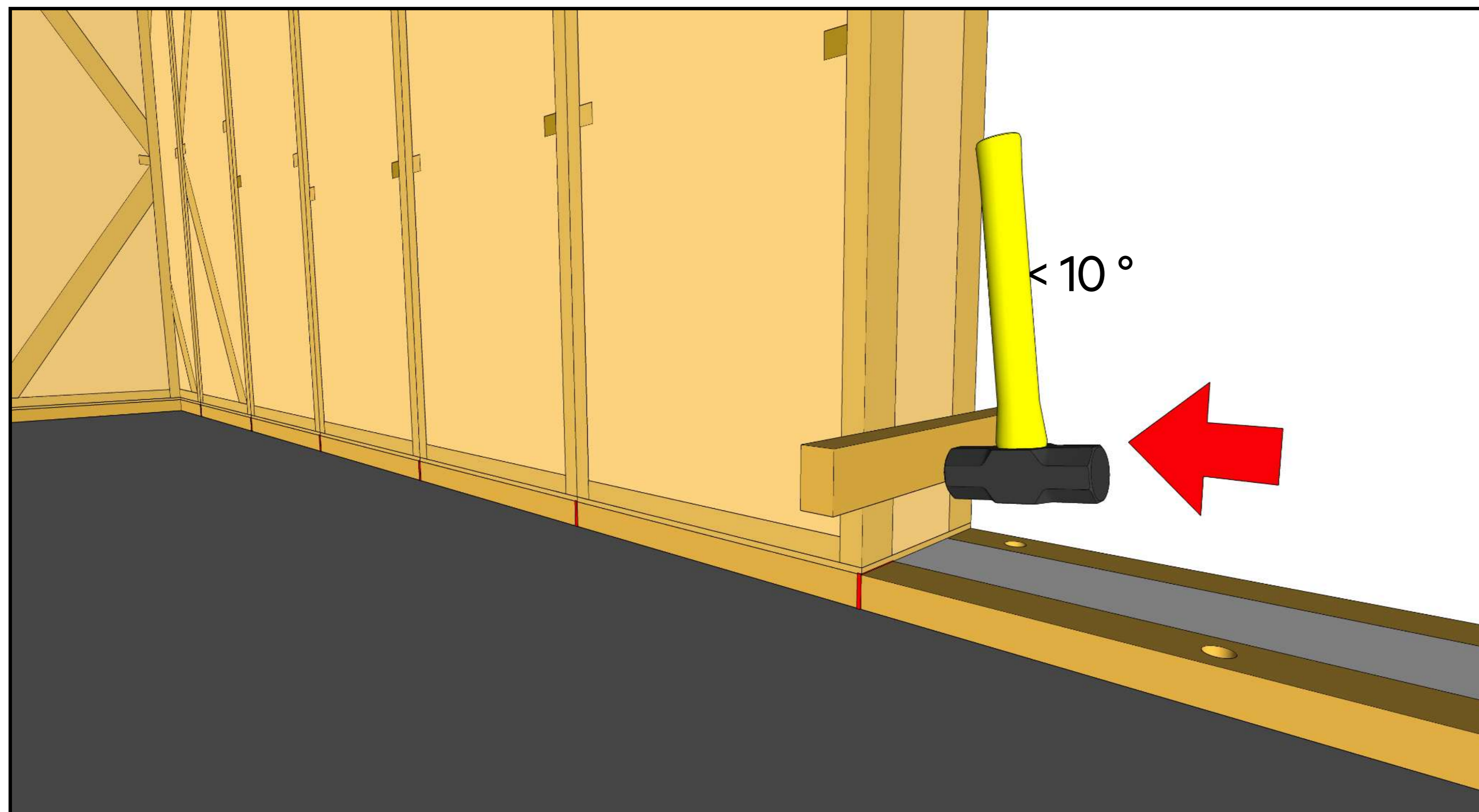

After assembling a wall section, check its position. Use a ratchet strap or lump hammer to adjust if needed.

16

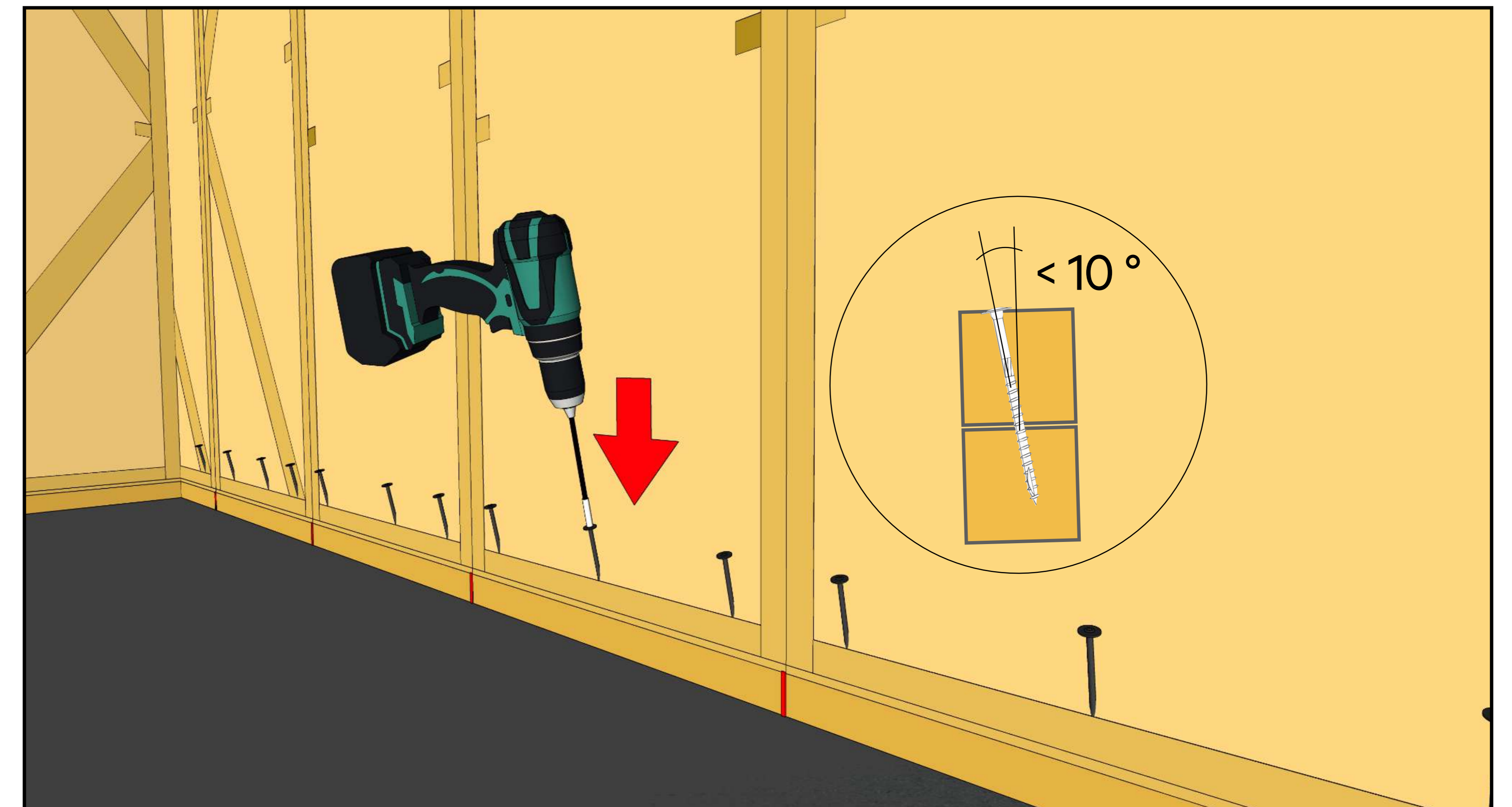

Only screw the wall to the inner and outer side of the base plate after mounting lintels and sills. Insert screws as perpendicular as possible, within a 10° maximum deviation.



# Scheme of Screws for Connecting the Panels

01

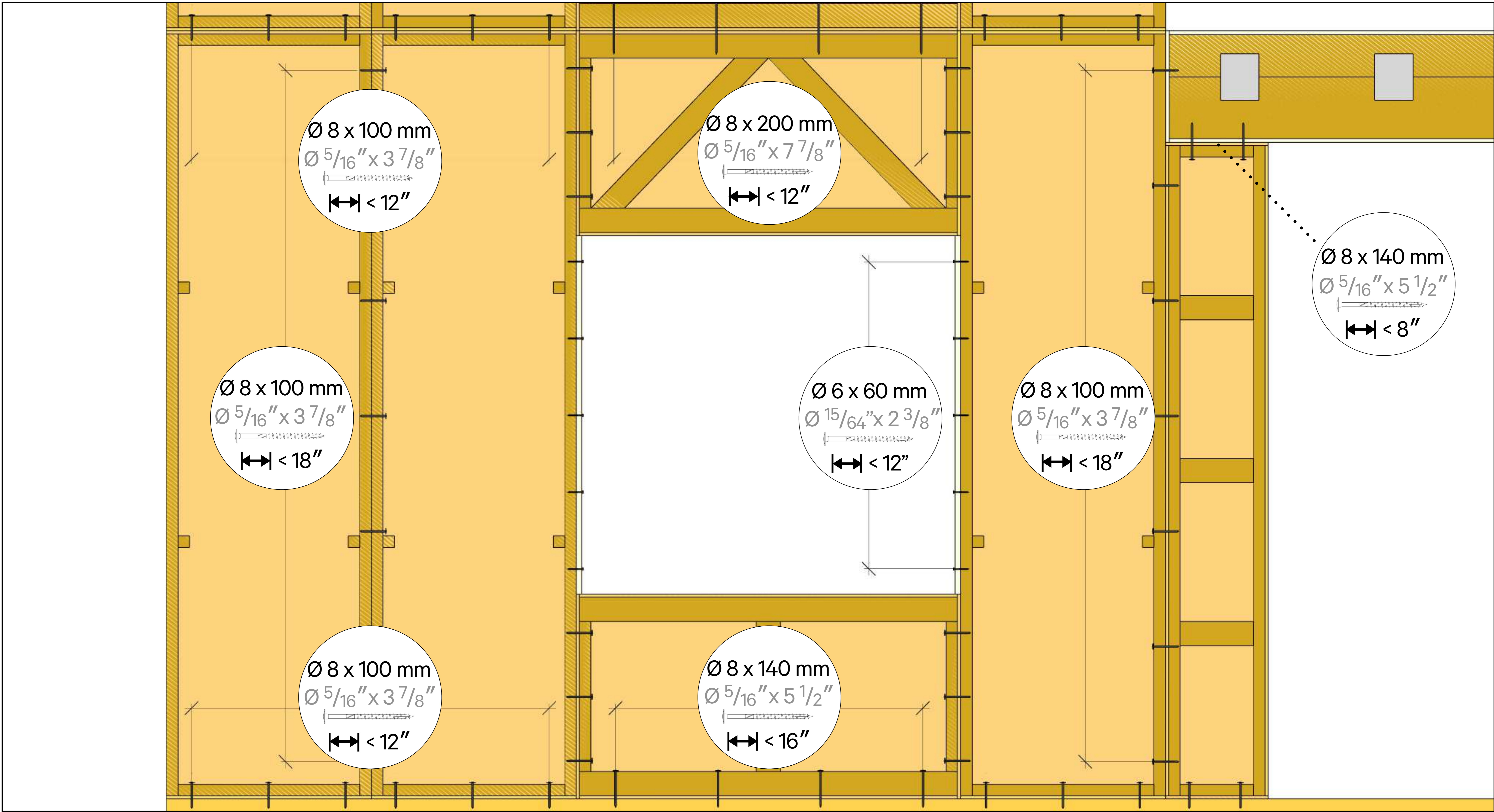

Scheme of screws for connecting different panel types (inside & outside).  
 Use a flange button head screw to tie the panels together.  
 Insert screws as perpendicular as possible, within a 10° maximum deviation.



Always follow the architectural and structural drawings. If the Panel Project specifies different screw or component placements, these take precedence over the Assembly Guide.



# Lintel Assembly

01

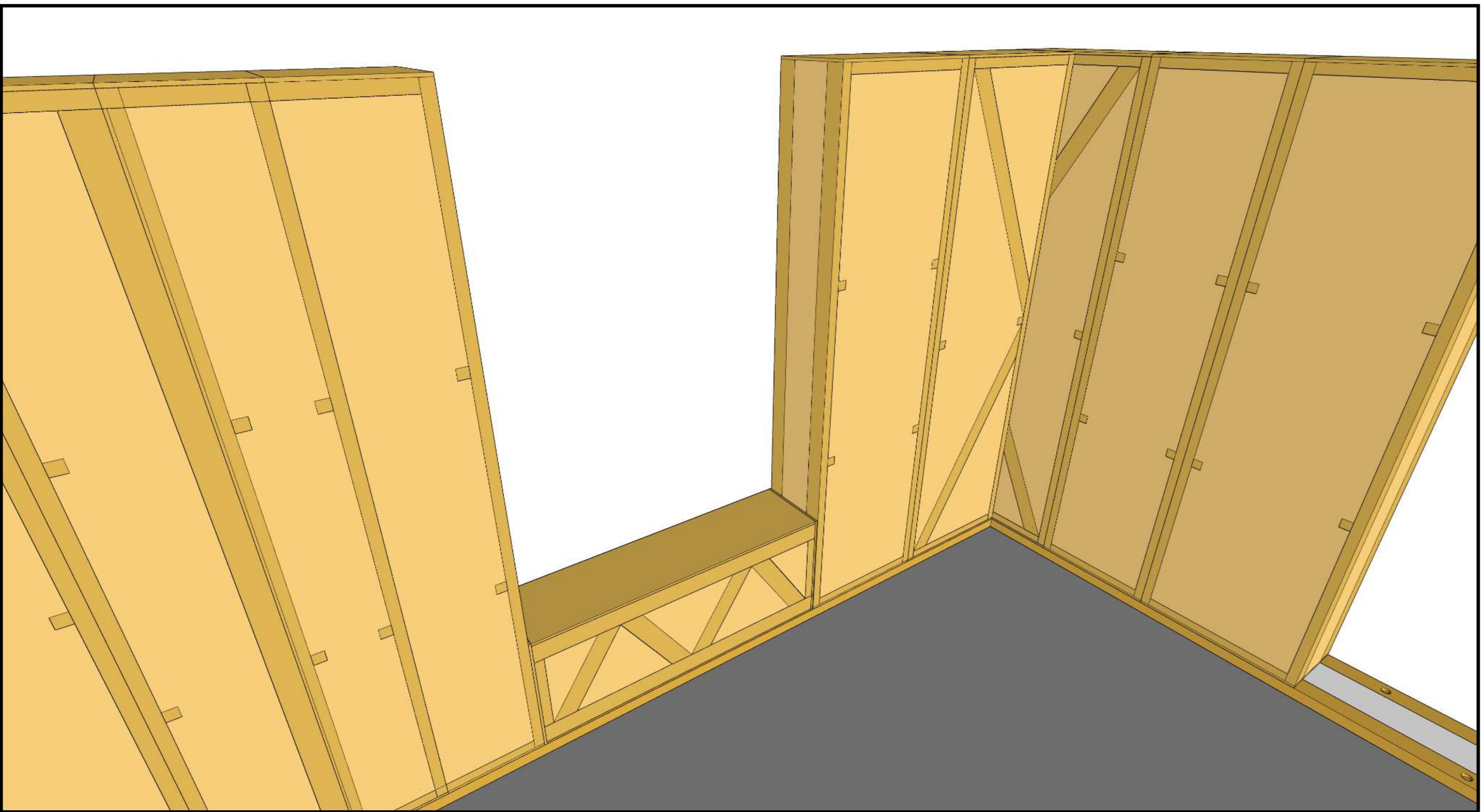

Place the lintel on the base plate in order to ensure the correct spacing between panels.

02

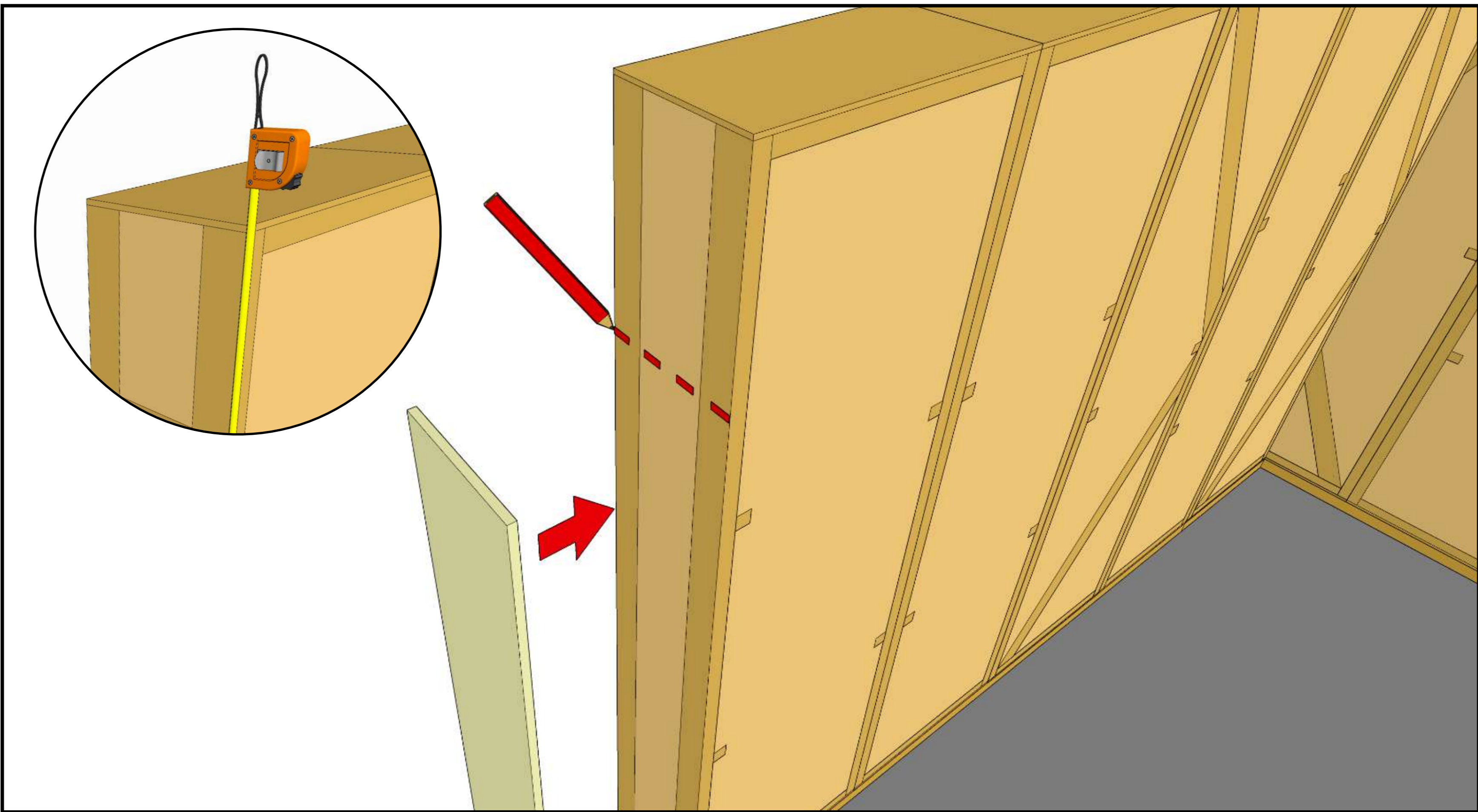

Measure and mark the lintel position.

03

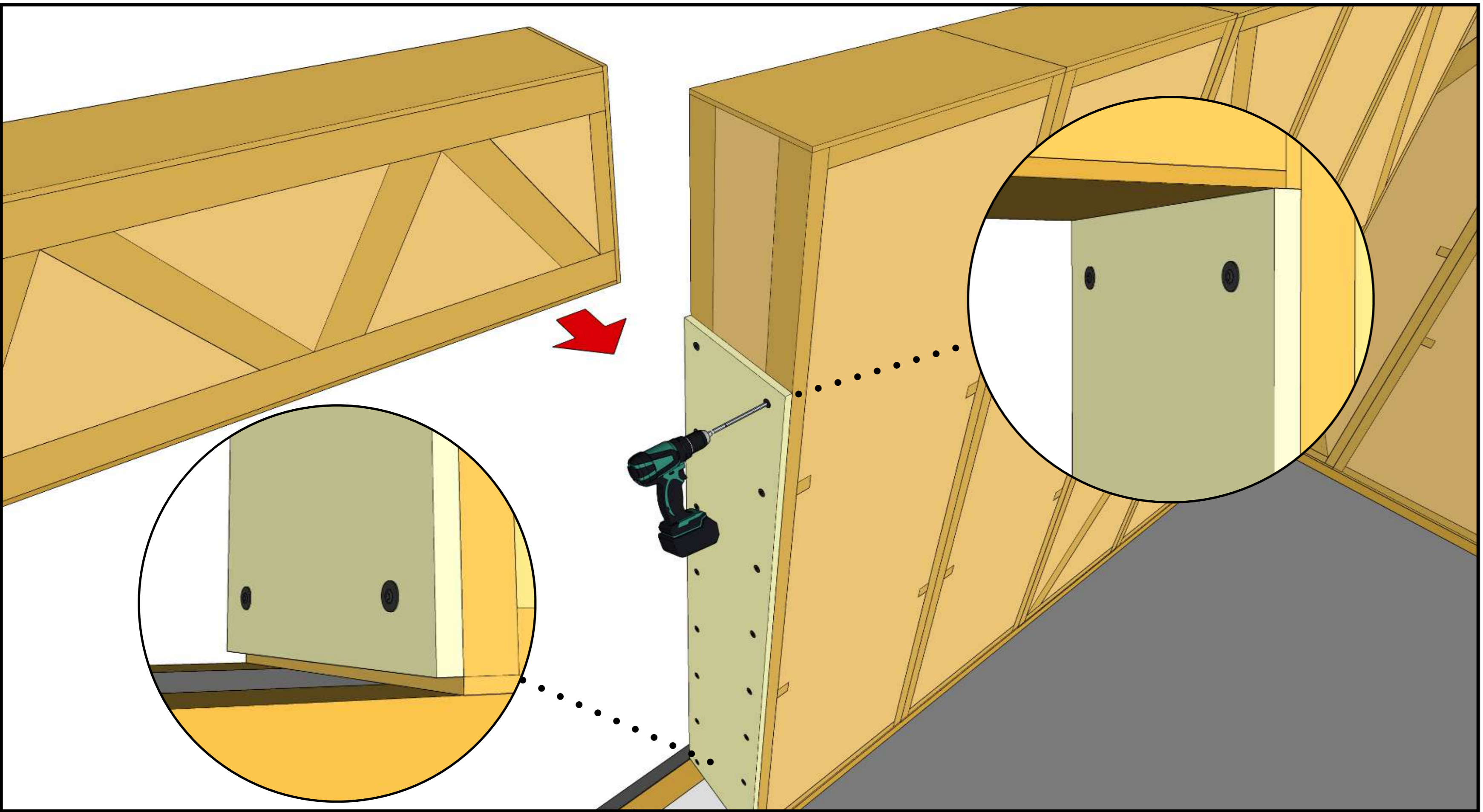

Fix the plywood boards for the window reveal tight to the lintel. Leave a small ( $3/32$  inches) gap at the bottom.

04

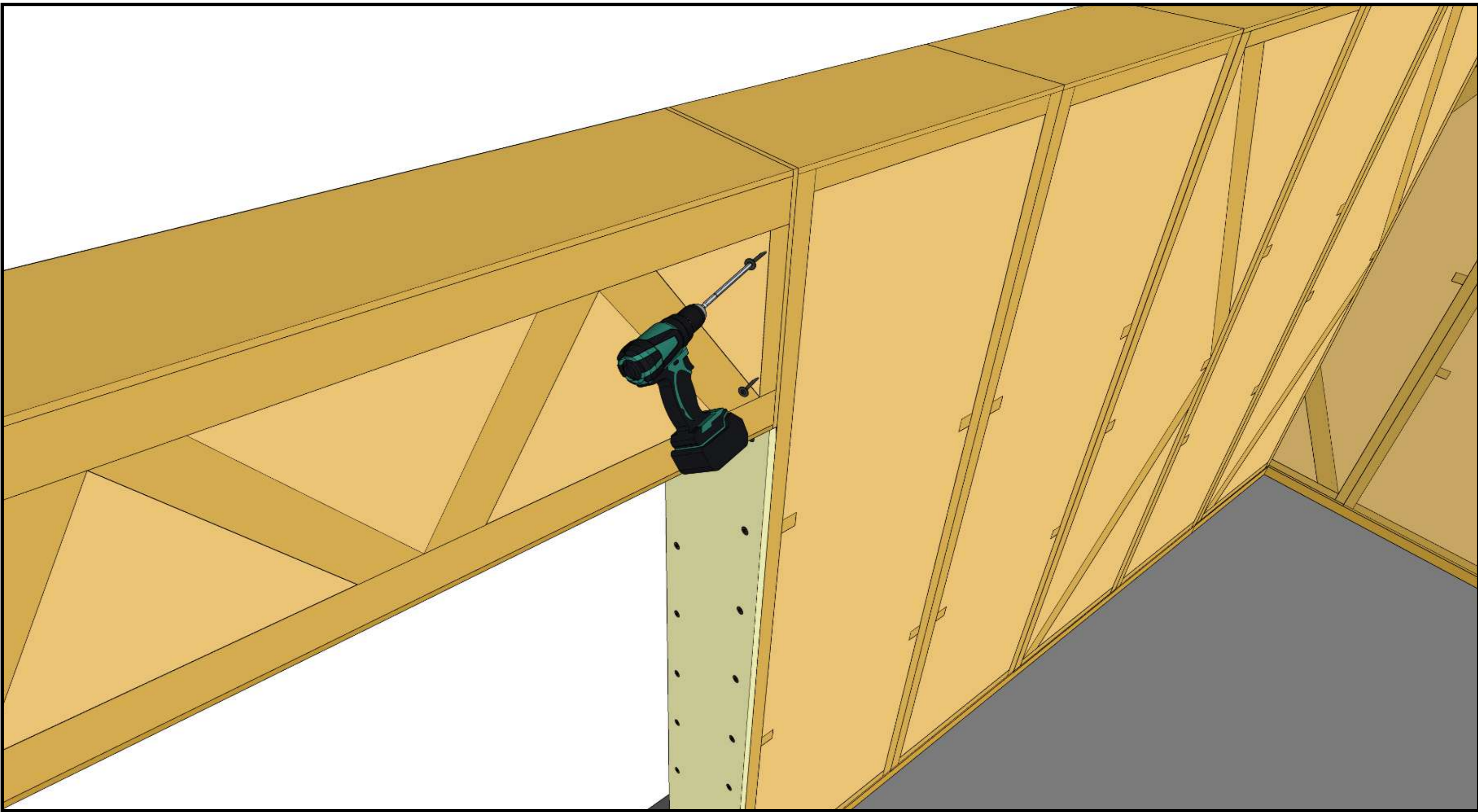

Screw the lintel to the wall.



# Narrow Lintel Assembly

01

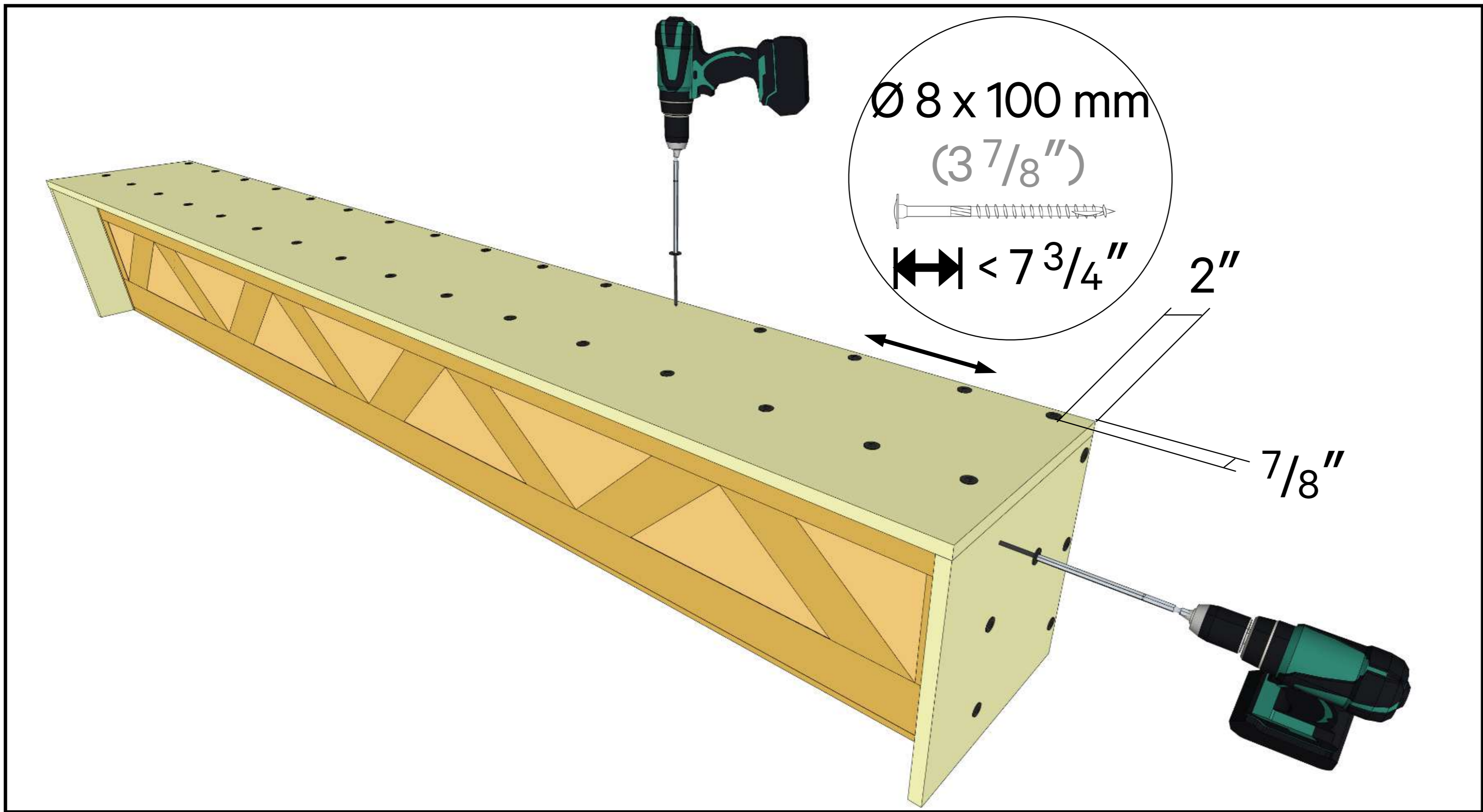

Fix the extra plywood on the sides and on the top of the lintel.

02

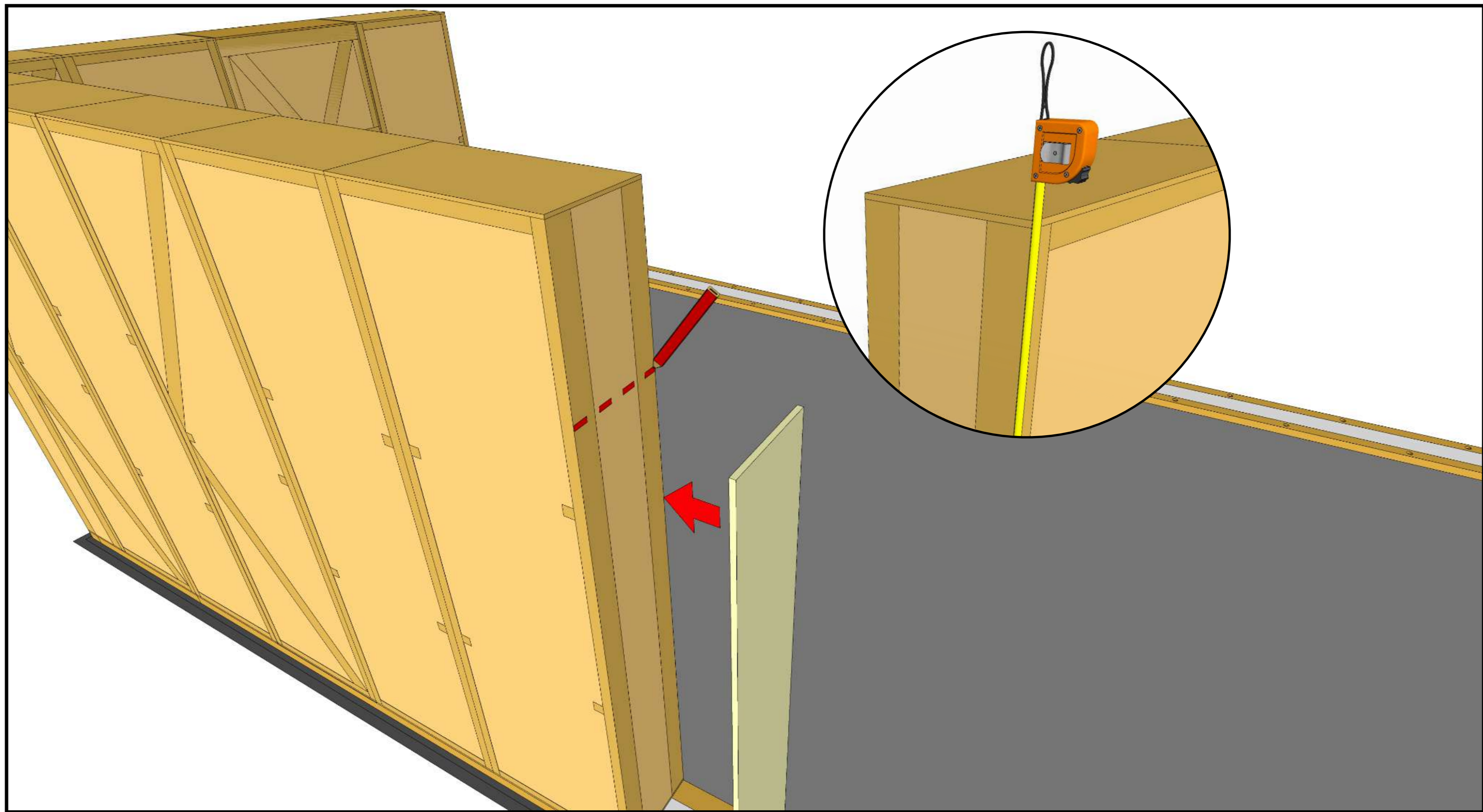

Measure and mark the lintel position.

03

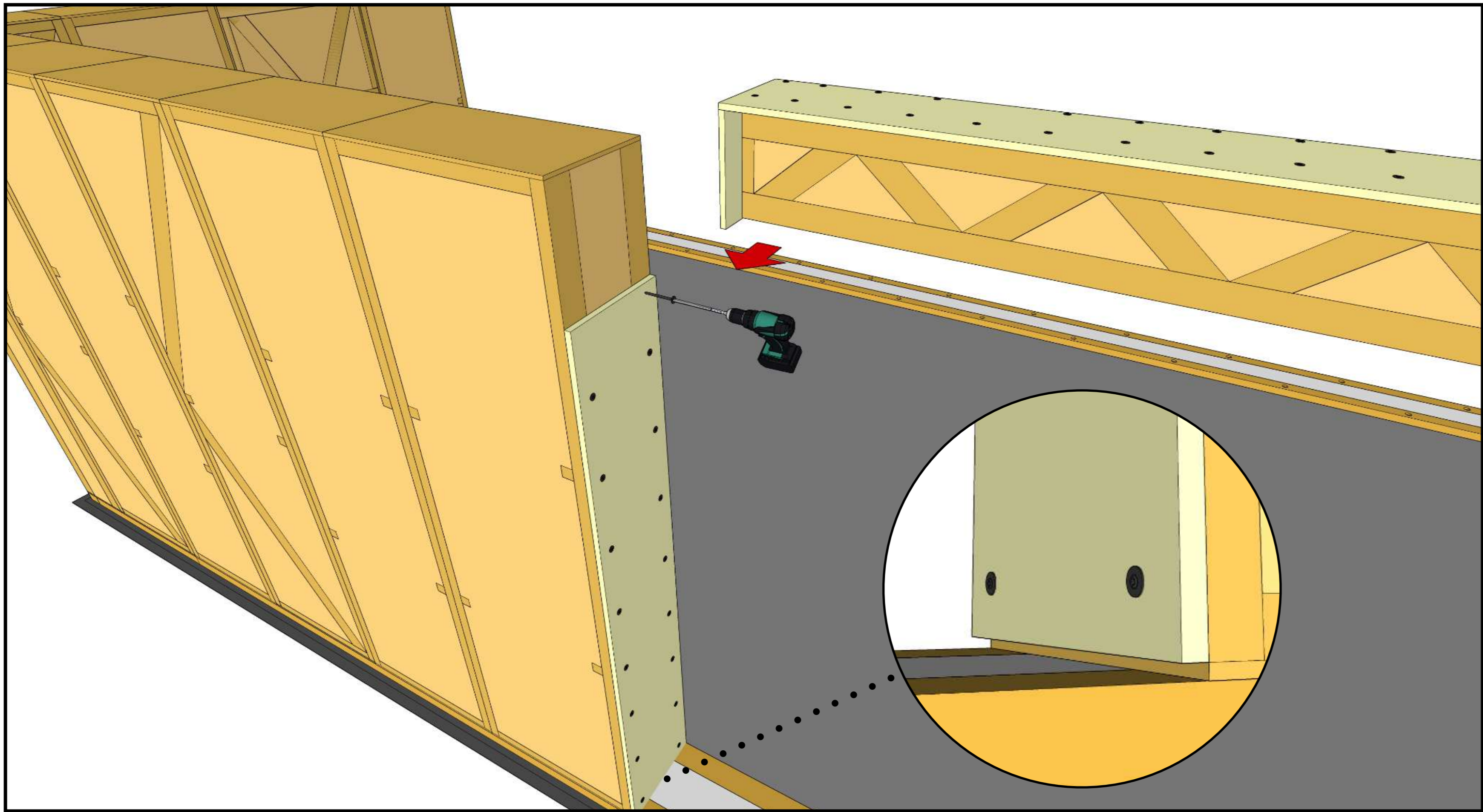

Fix the plywood boards for the window reveal tight to the lintel. Leave a small (approximately 3/32 inches) gap at the bottom.

04

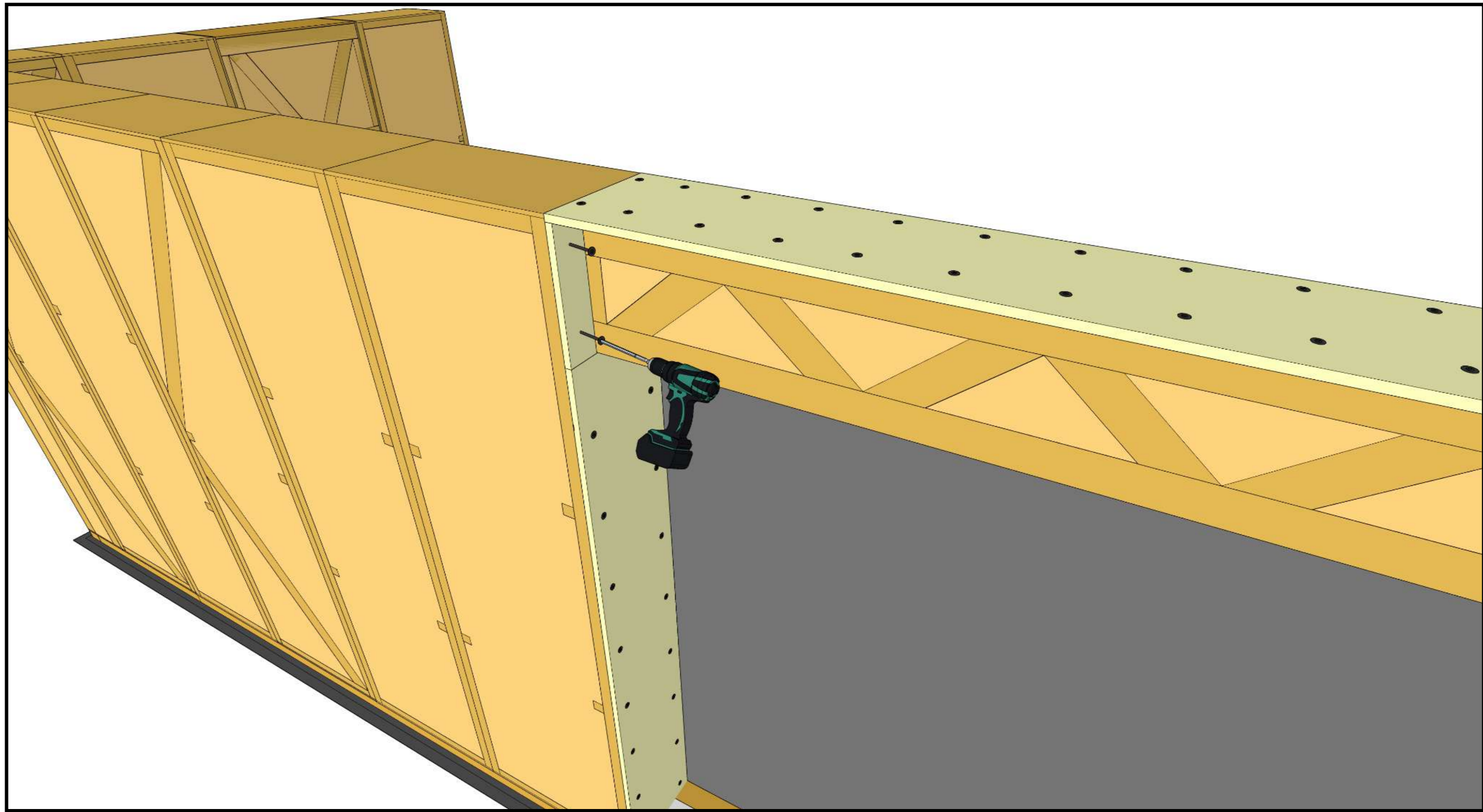

Lift the lintel into position and screw to the wall. On the exterior side screw through the plywood.



# Box Element Installation

01

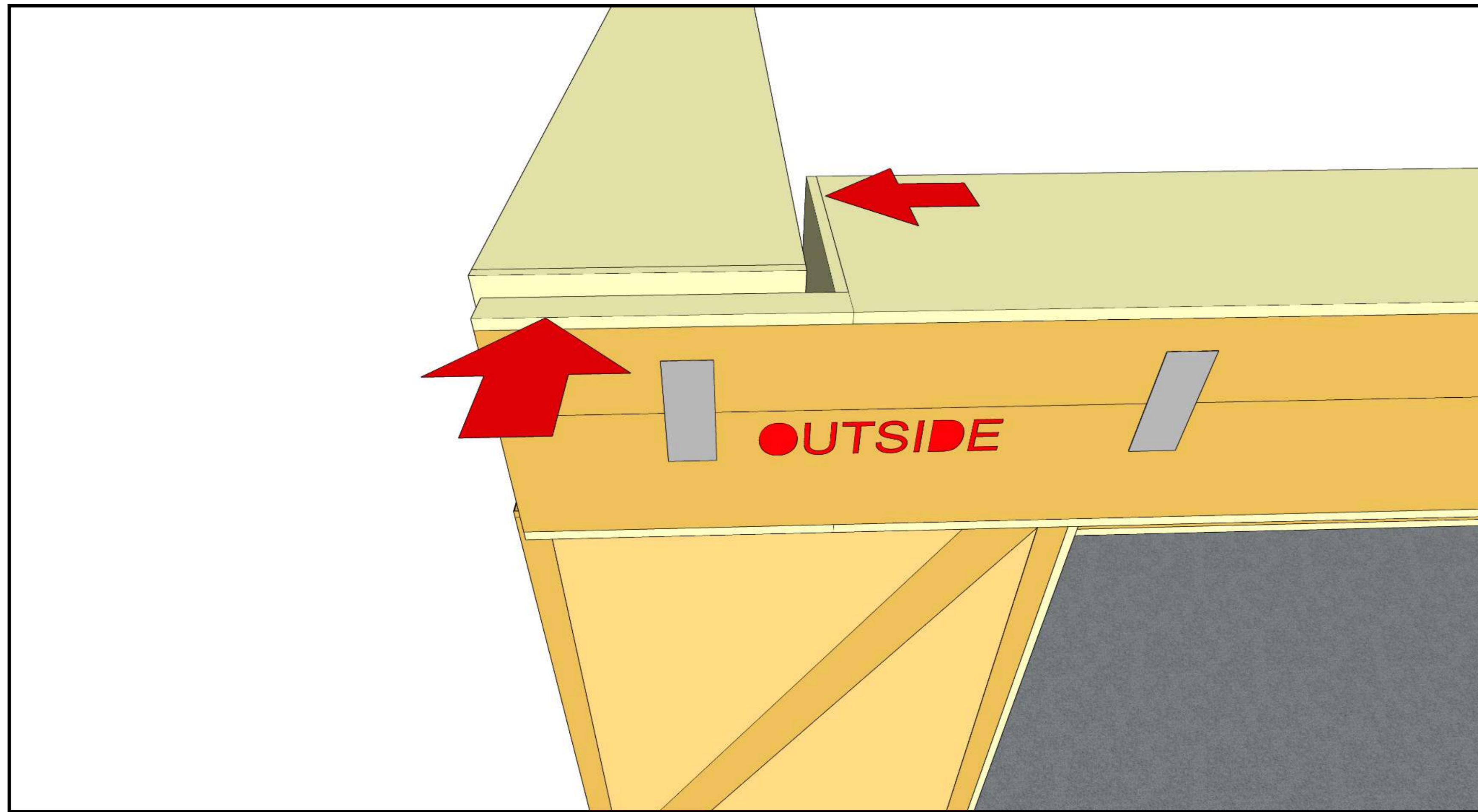

Place Box elements with stamp on the outside. If Box elements meet on the corner, they are pre-prepared to interlock.

02



Screw the extended plywood piece of one Box element to the side of the other.

03

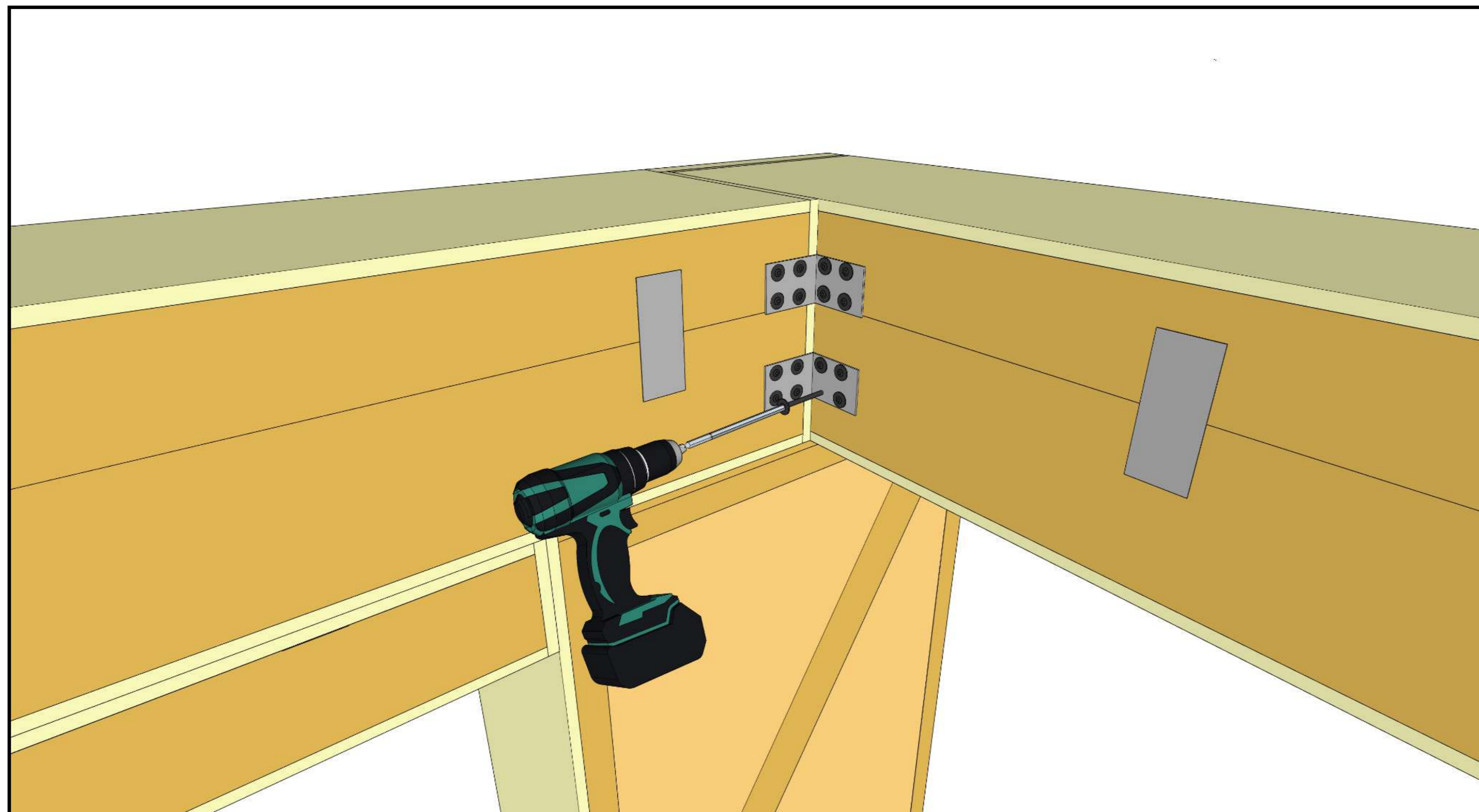

Use angle brackets on the inside.

04

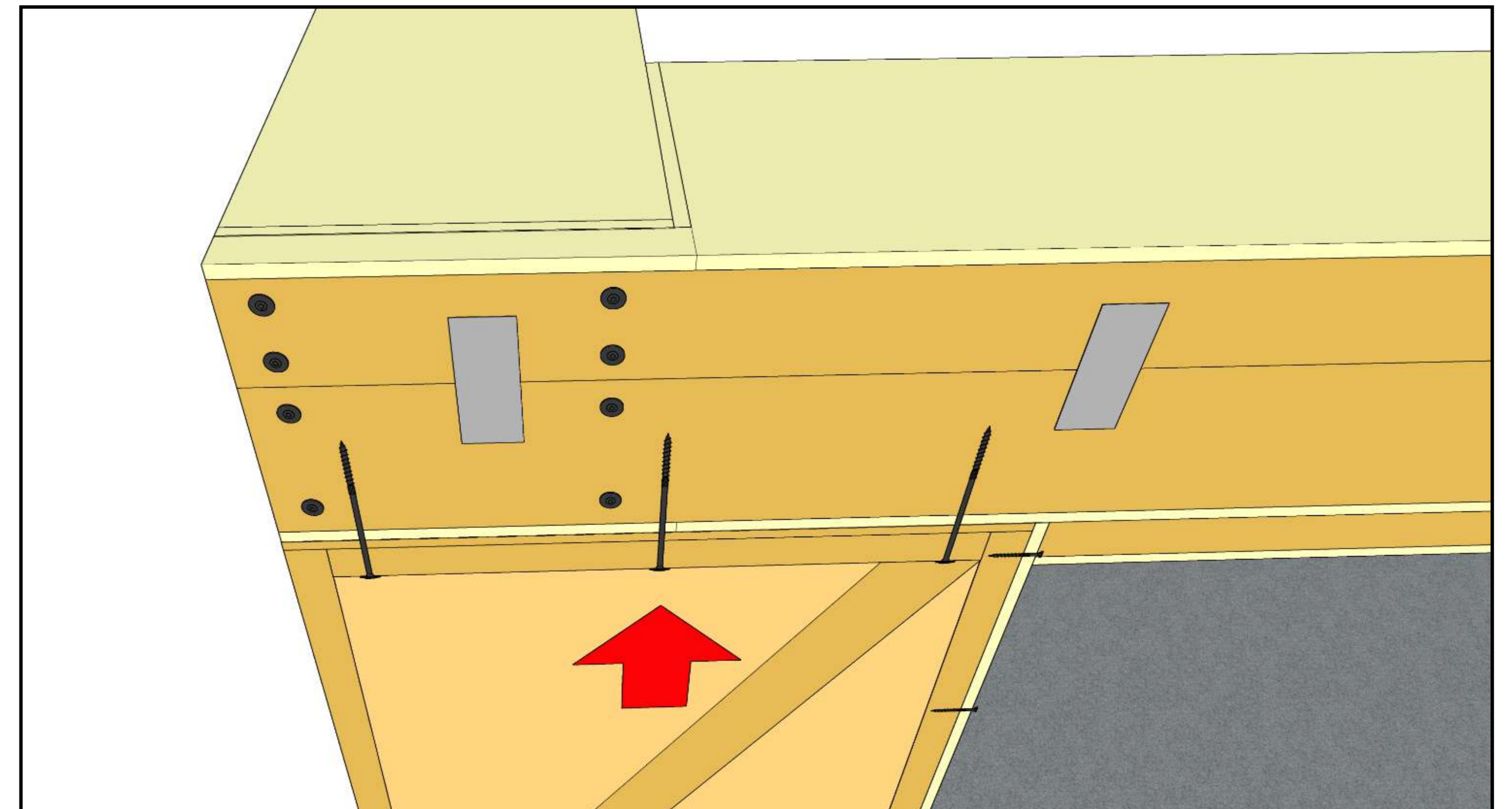

Fix the Box element to the panels by screwing through the panel to the Box element above.



# Airtight Membrane Installation

01

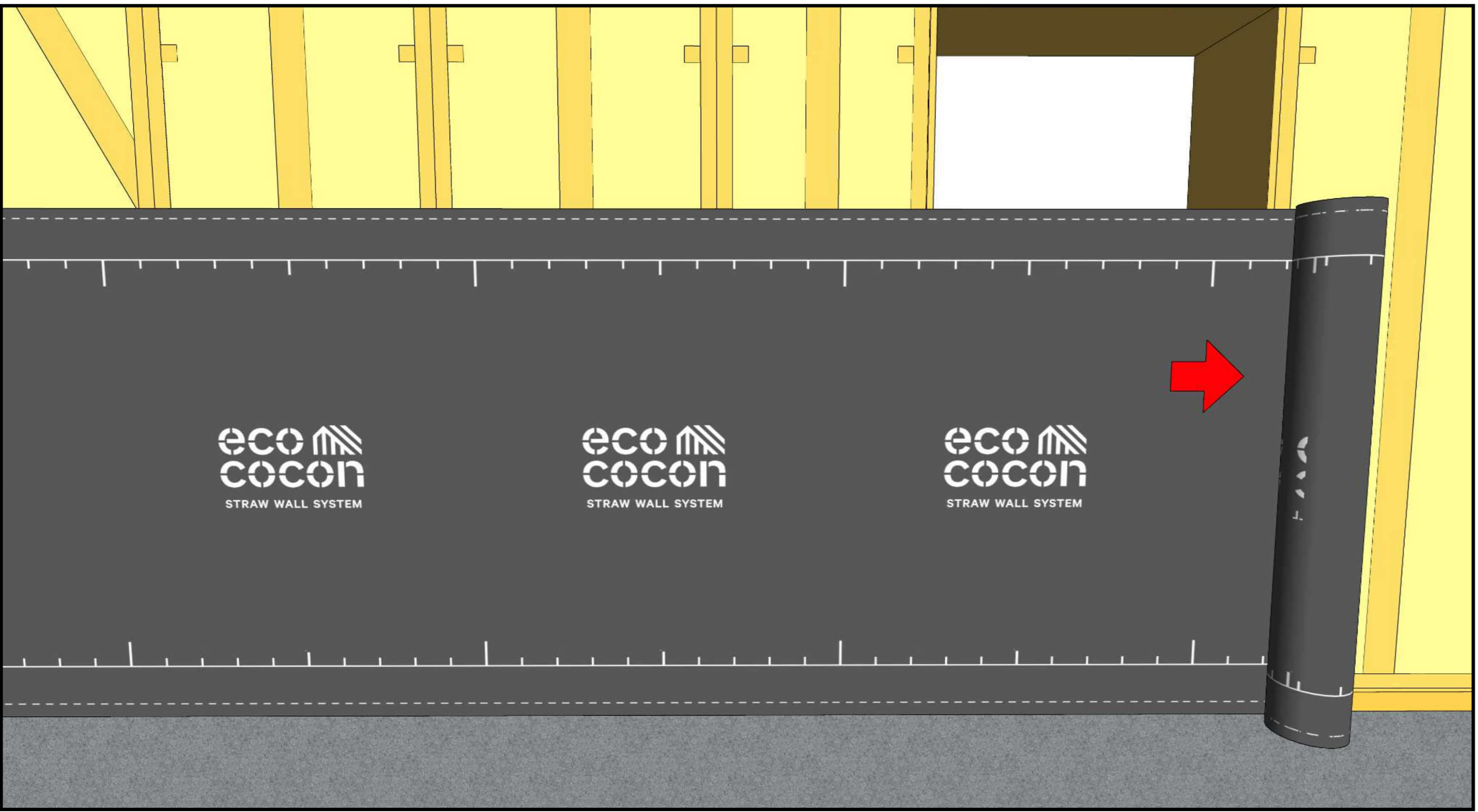

On the exterior wrap the airtight membrane horizontally from the bottom. Cover over the window openings.

02

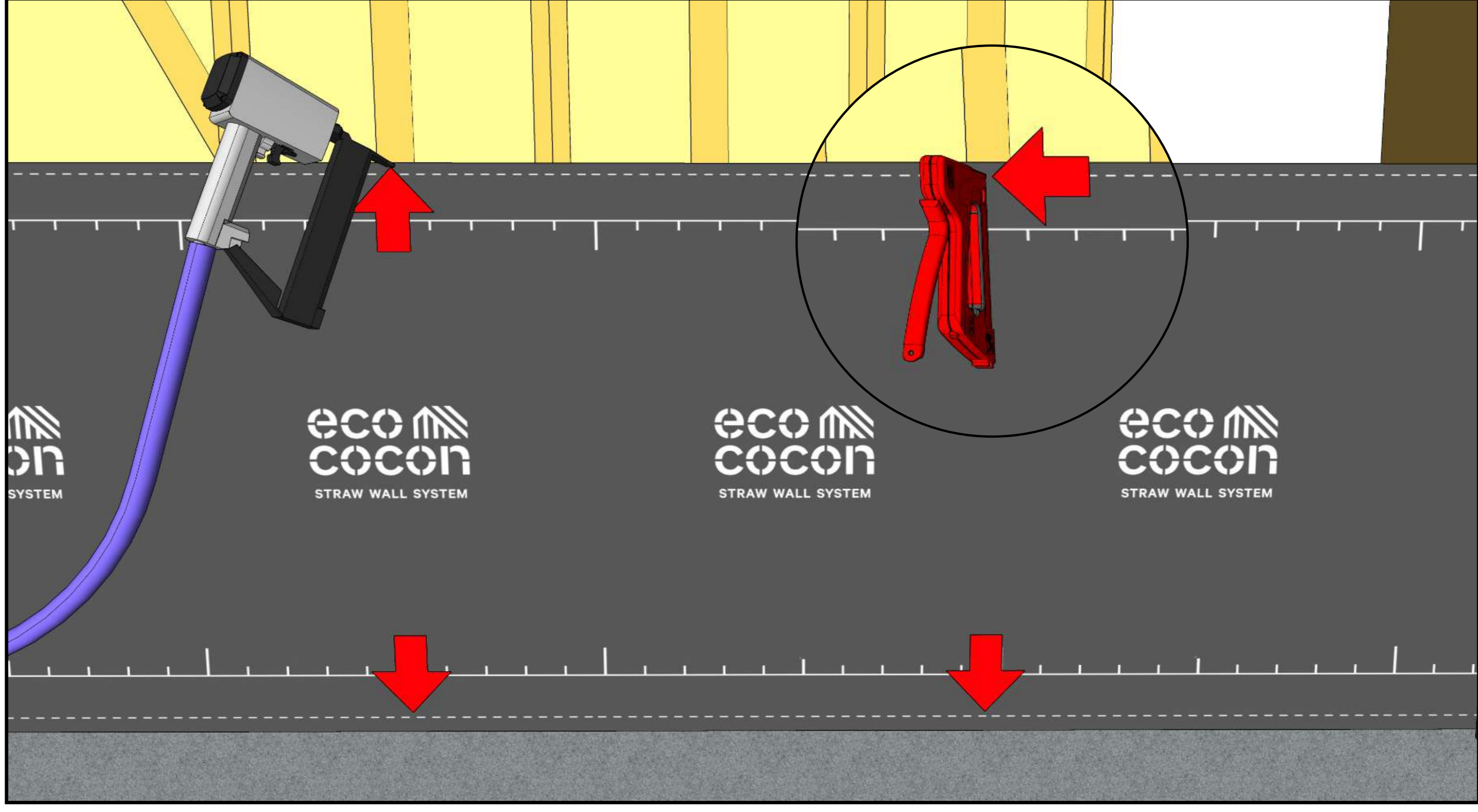

Fix the membrane with staples at top or bottom where the membrane overlaps.

03

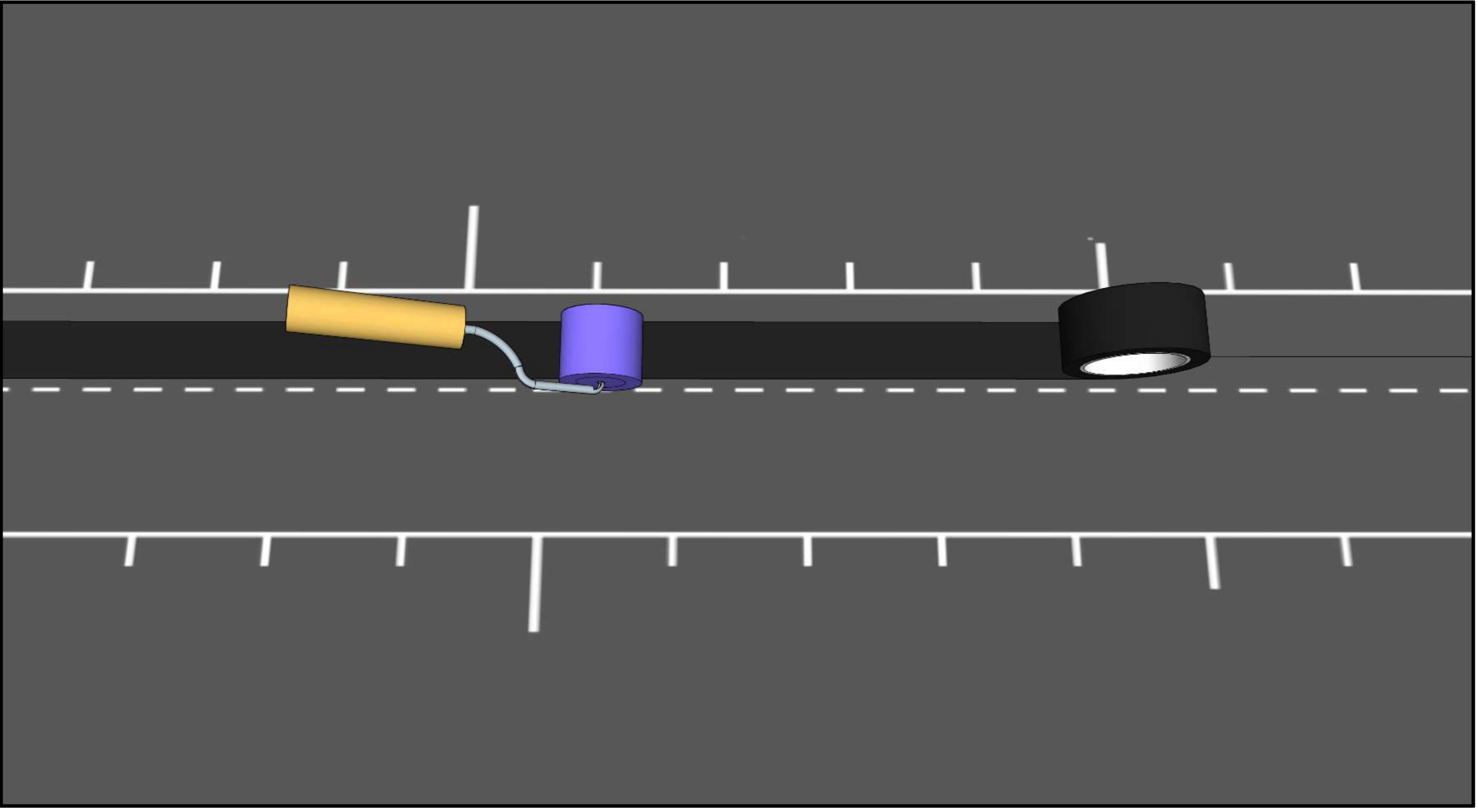

Seal connections with airtight tape and press the tape with a roller - pressure ensures strong adhesion.

04

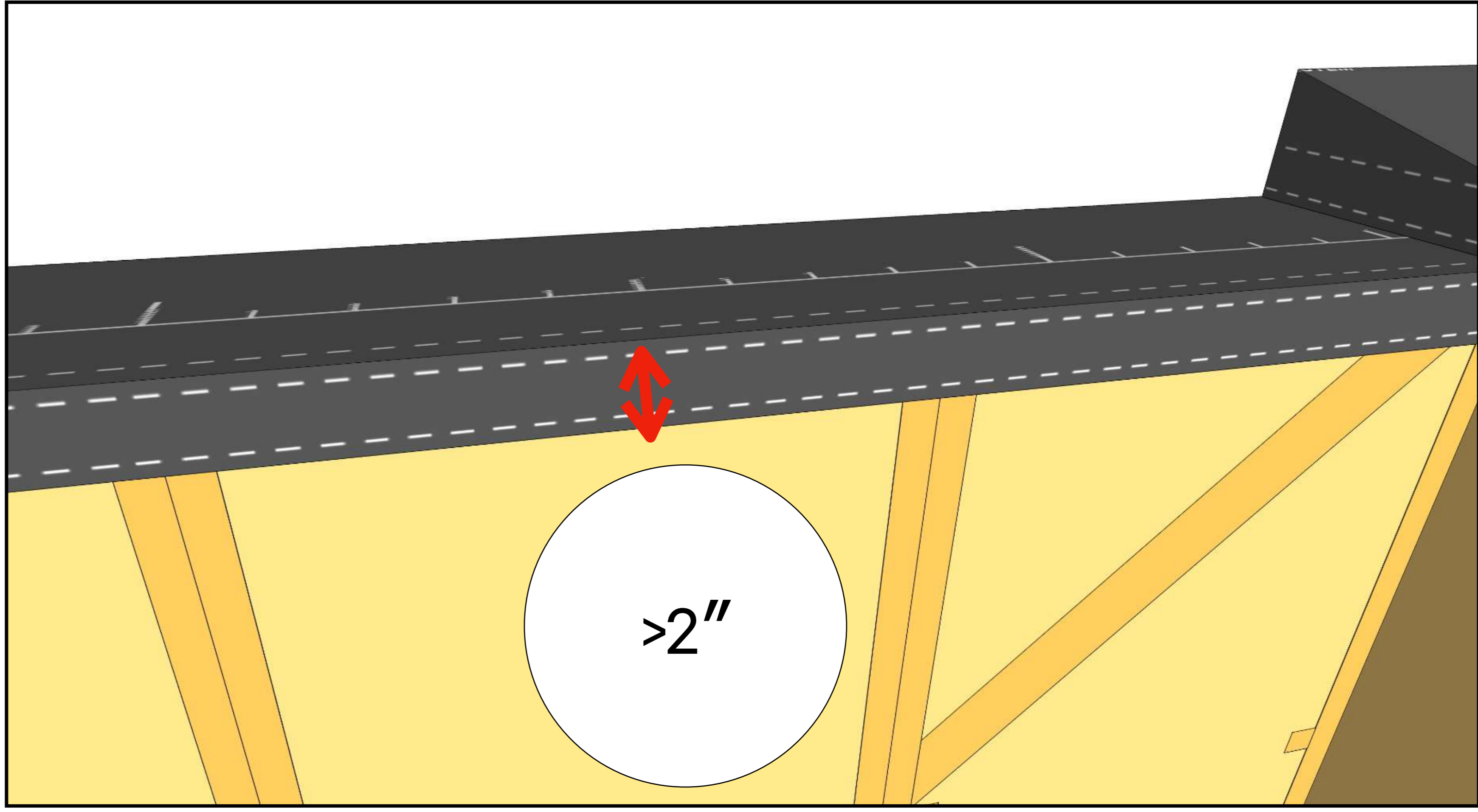

Flip the membrane over the top and leave 2 inches projecting to the interior side. If you pause work overnight, ensure the top is covered with a strip of membrane.



05

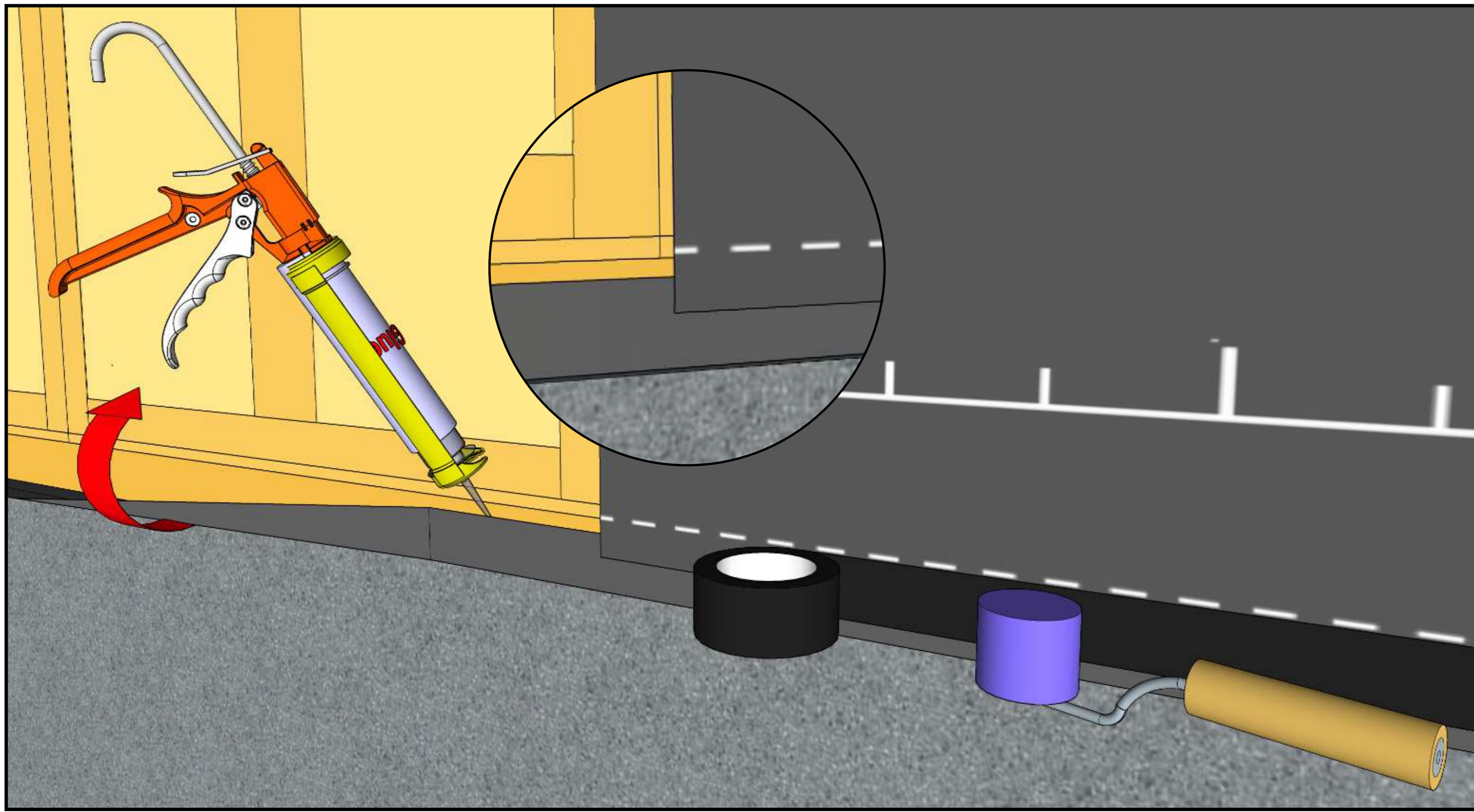

Ensure an airtight connection to the base plate by taping or glueing.

06

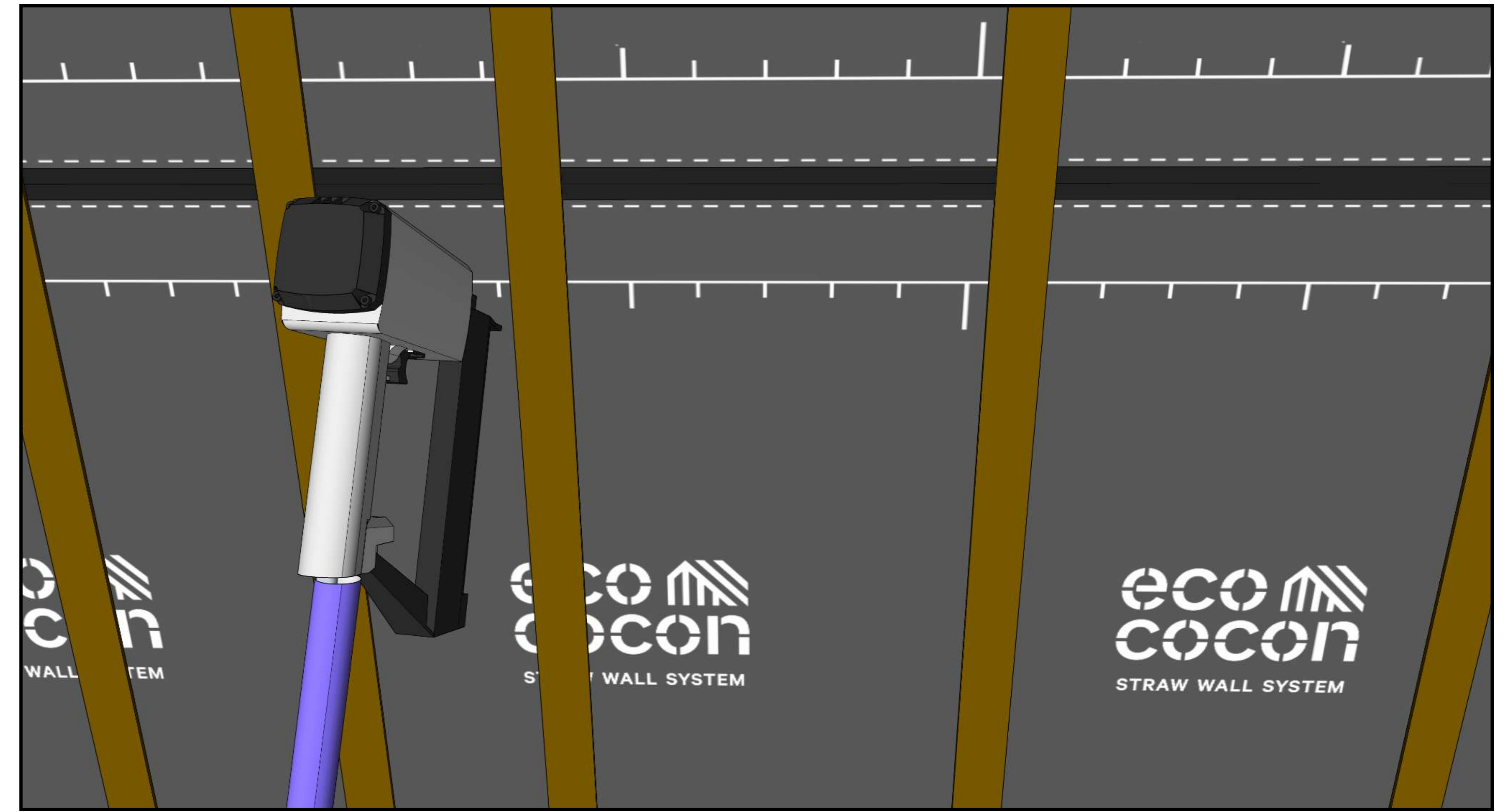

Staple plywood strips to fix the membrane only on vertical posts.

07

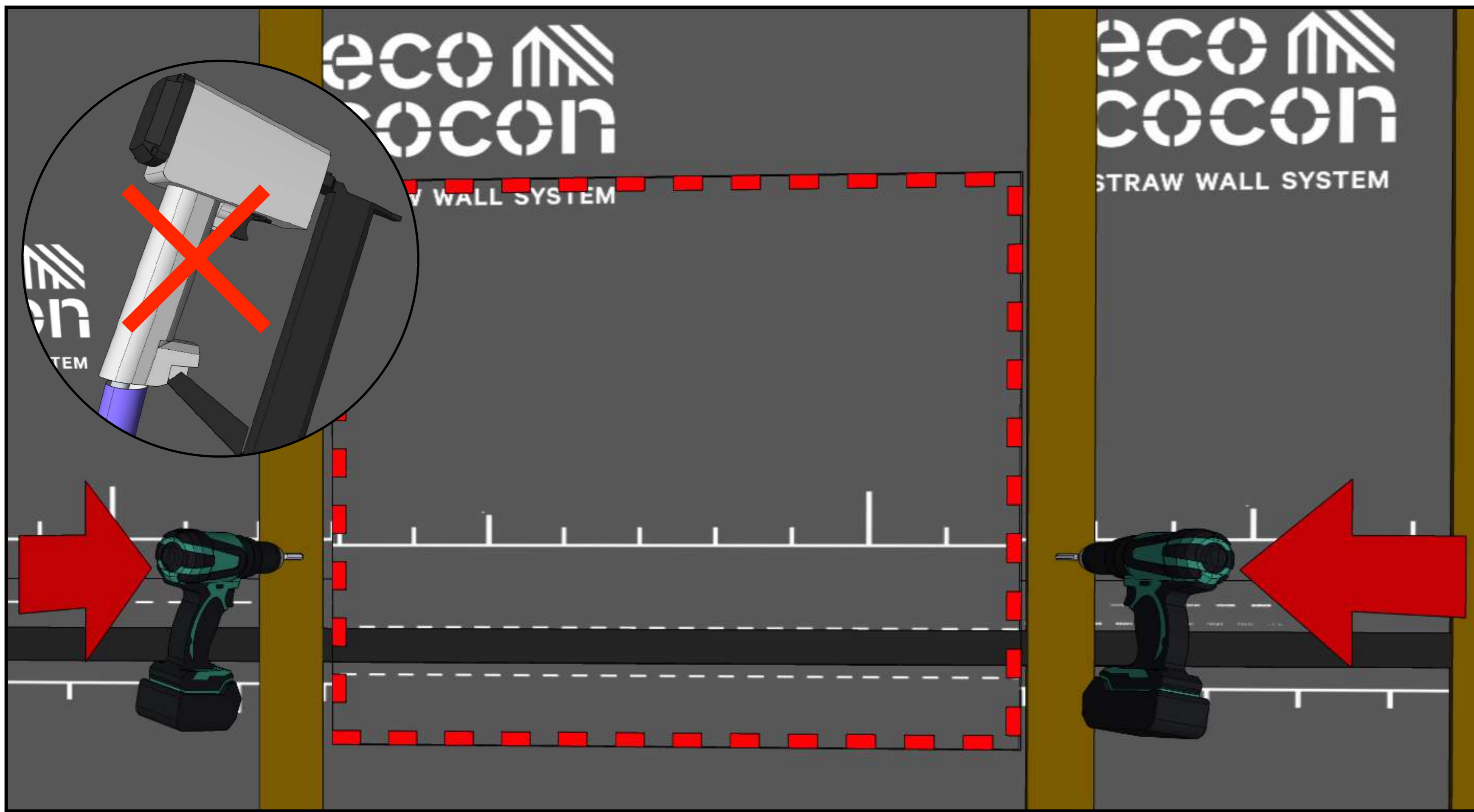

Fix vertical plywood strips next to wall openings only with screws. Do not staple them; they must be temporarily removed and reattached when mounting the windows.

08

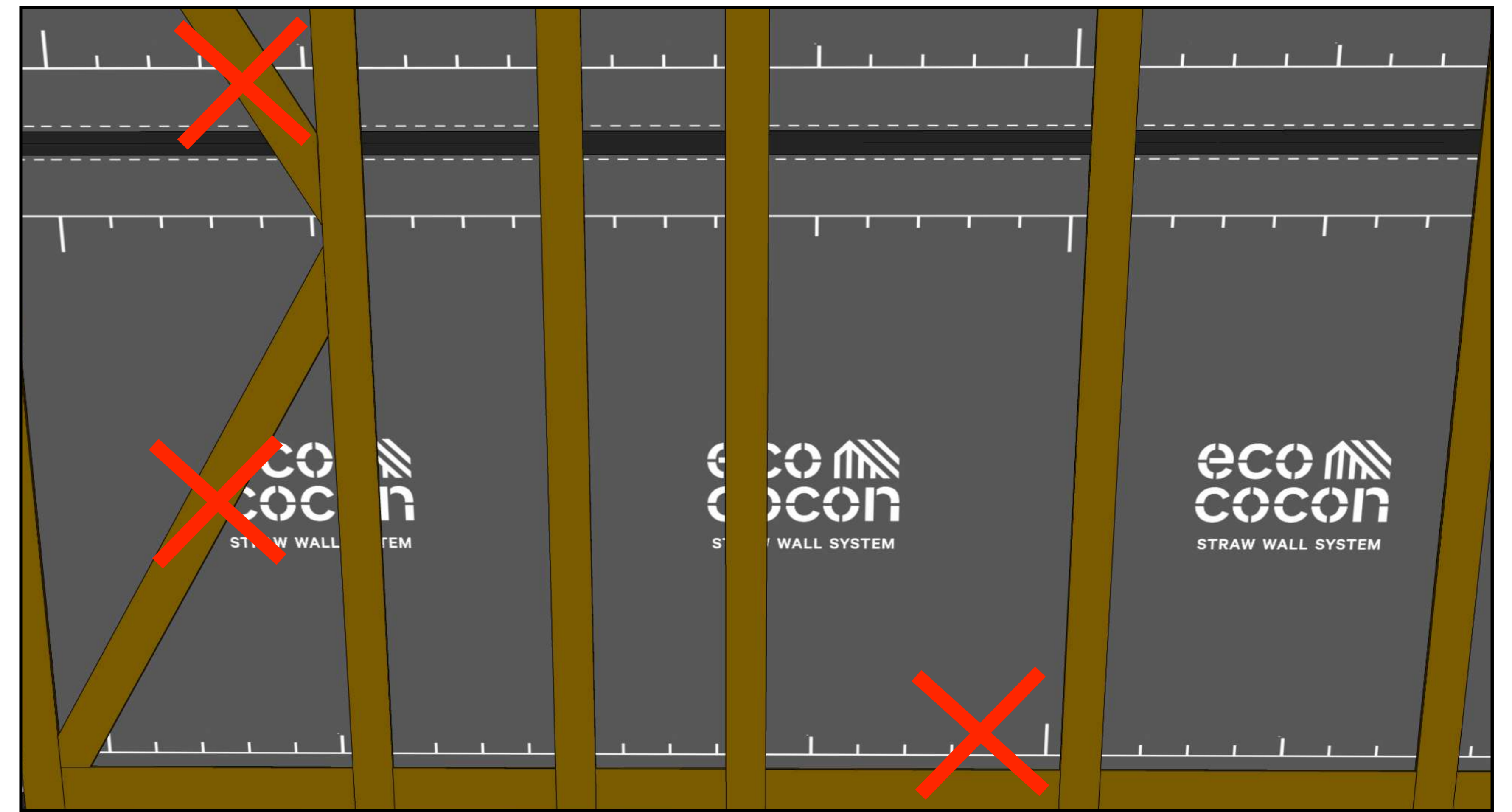

Do not add diagonal and horizontal strips yet.

# Metal Plates and Braces

01

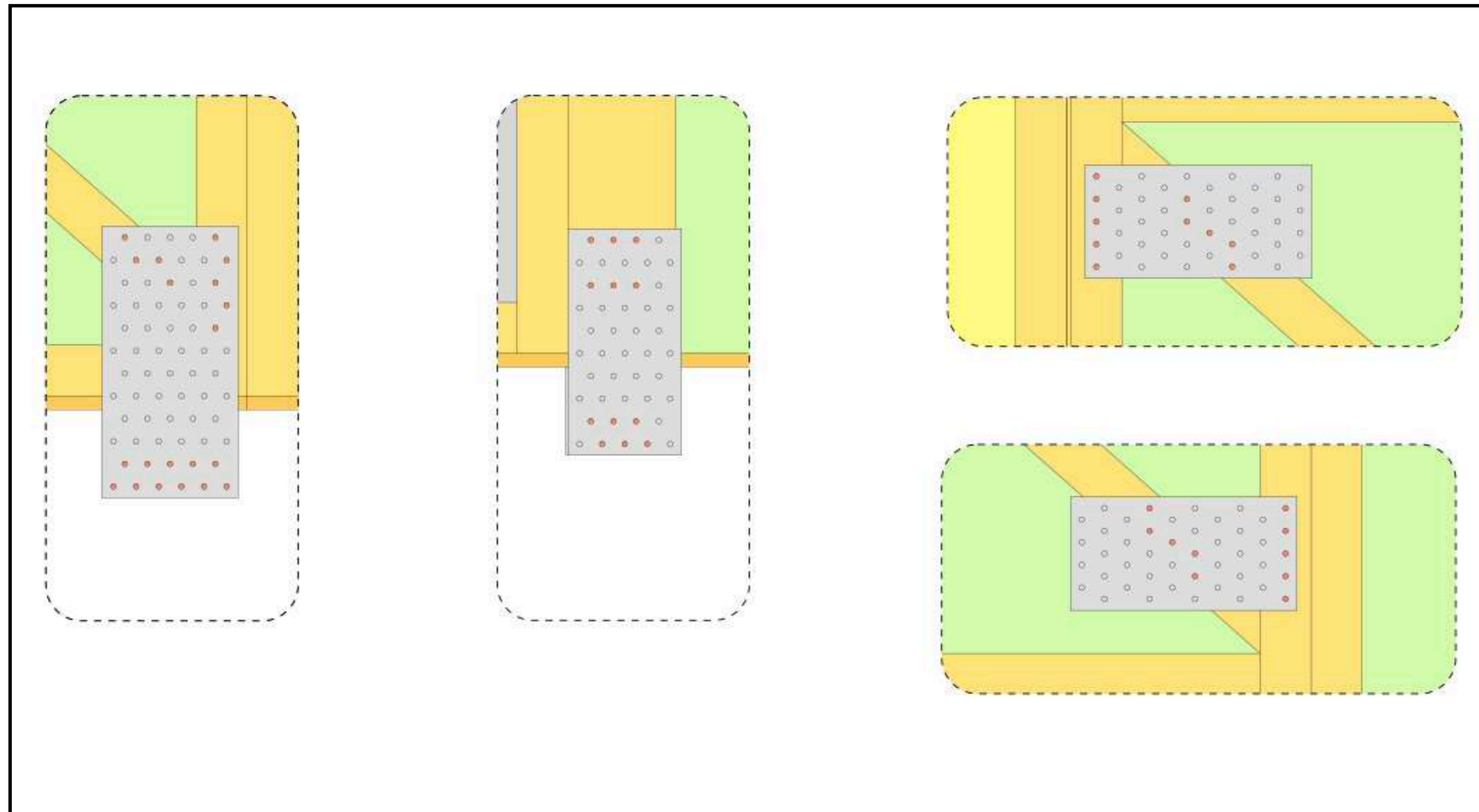

Check the Panel Project to see if reinforcement or extra anchoring to the bottom plate is required. If so, perforated metal plates, braces and screws are included in the delivery.

02

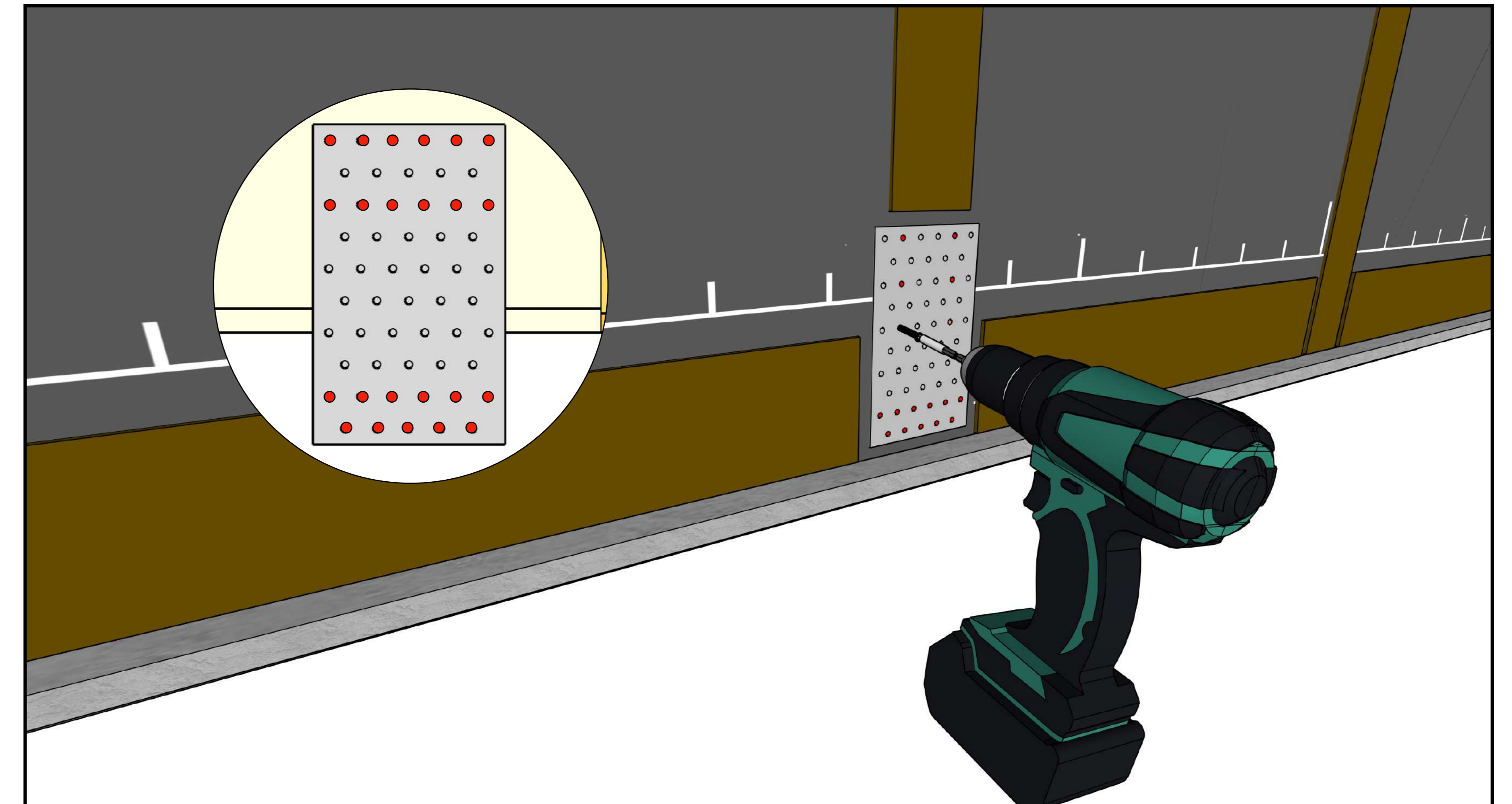

Insert screws into the holes marked in red. (It is recommended to use a foam weather strip under the plate, or tape over to prevent water ingress.)



# Temporary Weather Protection

01

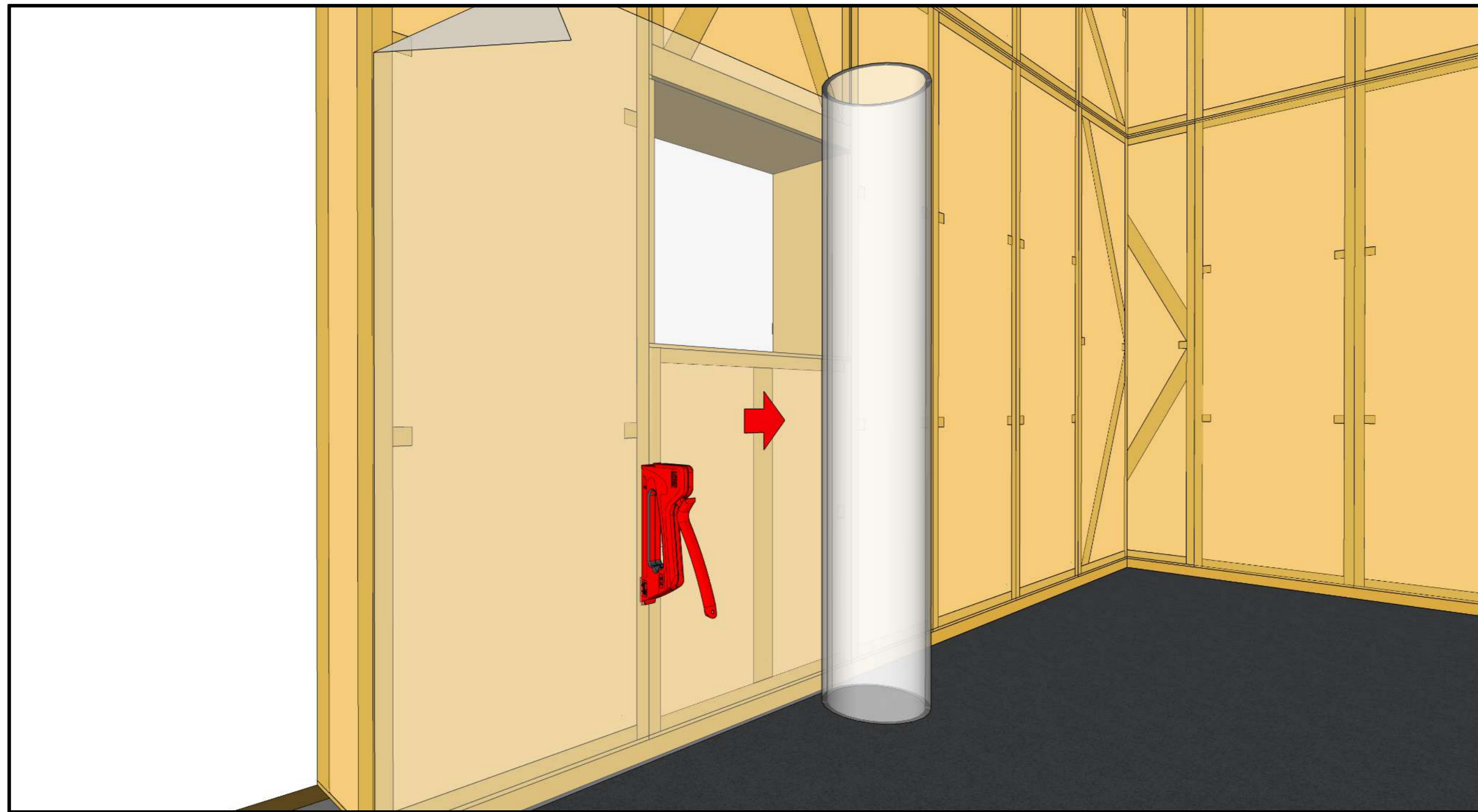

Wrap the interior part of the wall in a temporary transparent plastic sheeting. Do not leave on for more than two weeks.

02

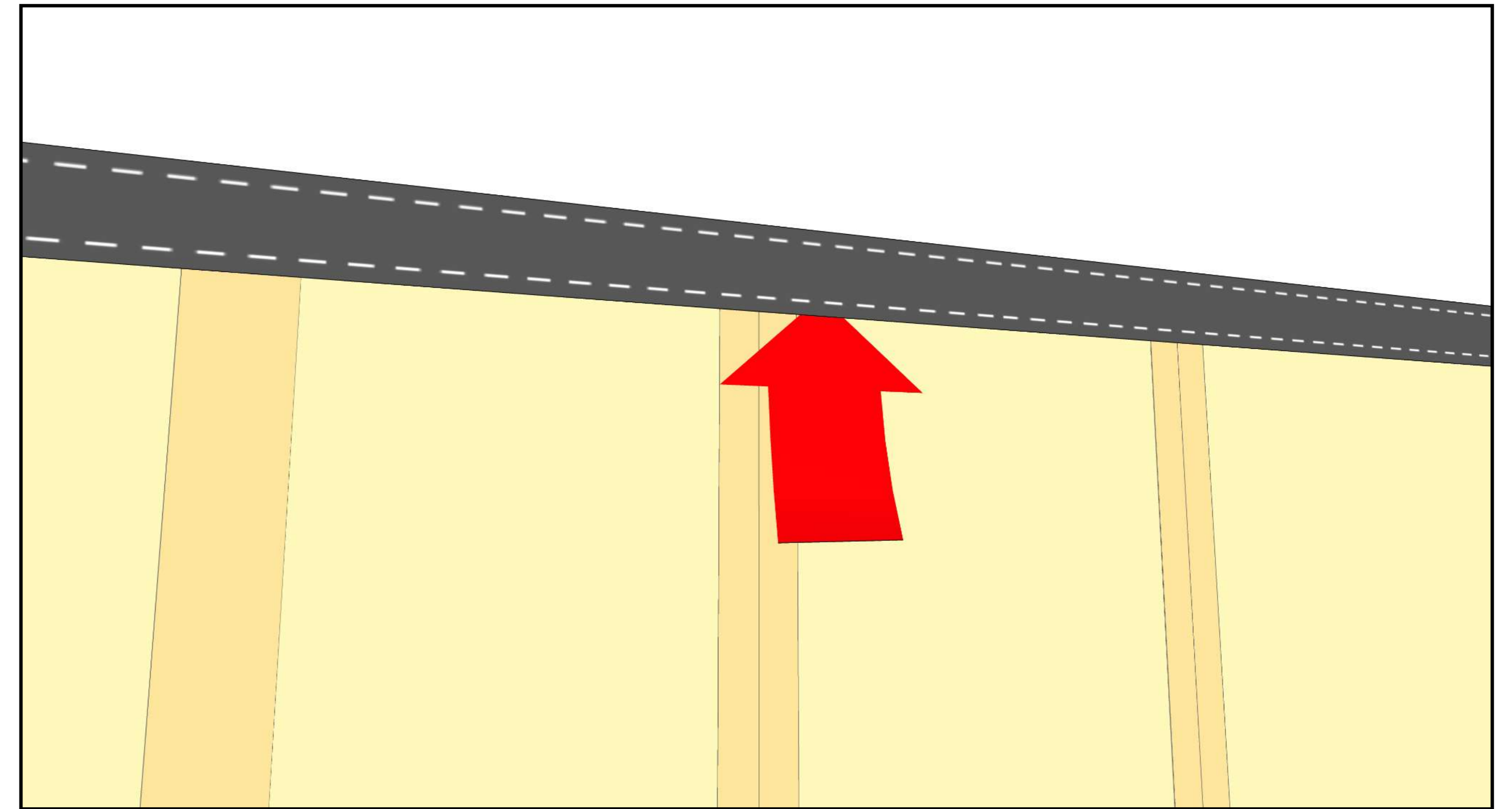

Put the plastic sheeting under the membrane on the top.

03

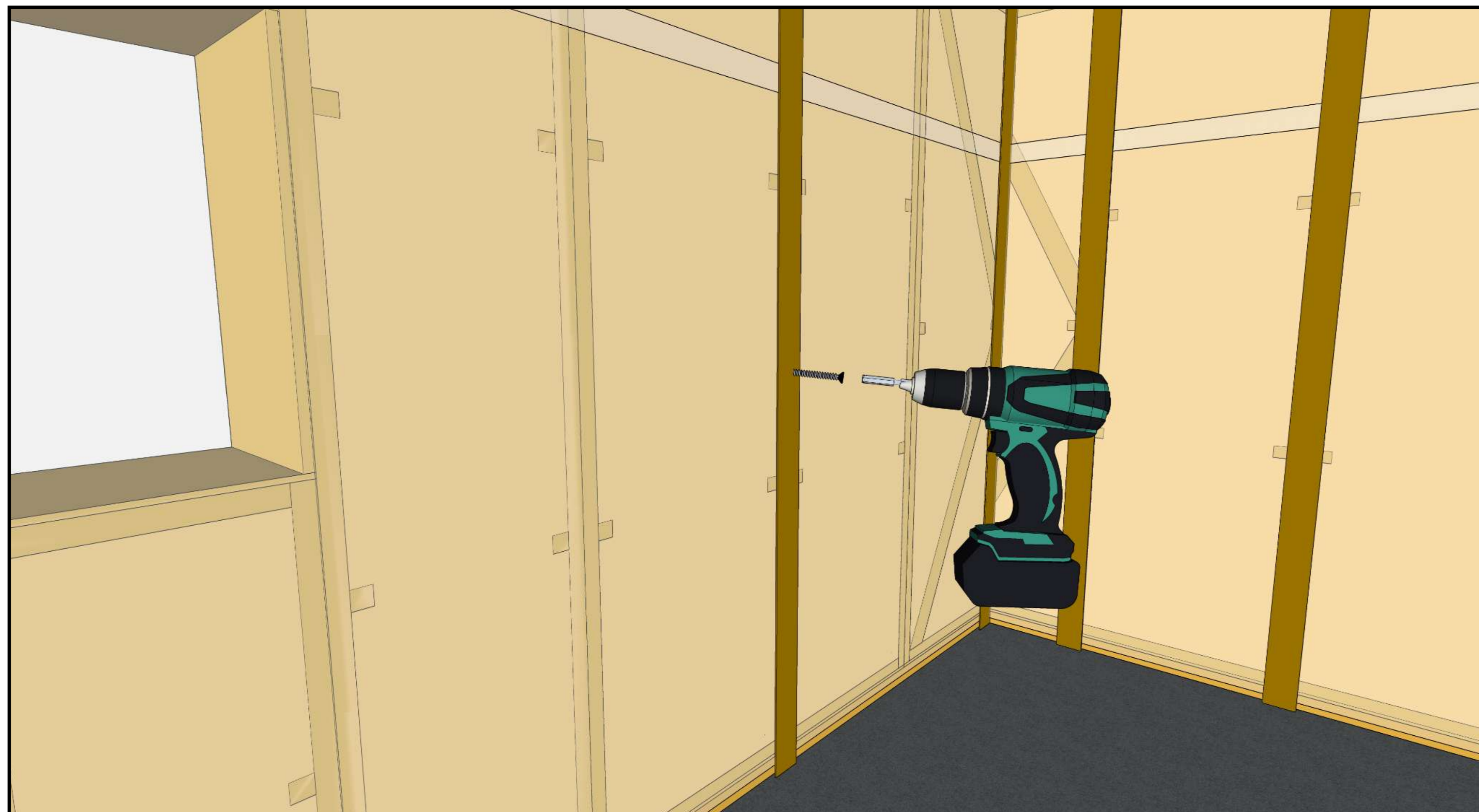

Fix the plastic sheeting with vertical plywood strips and screws.

04

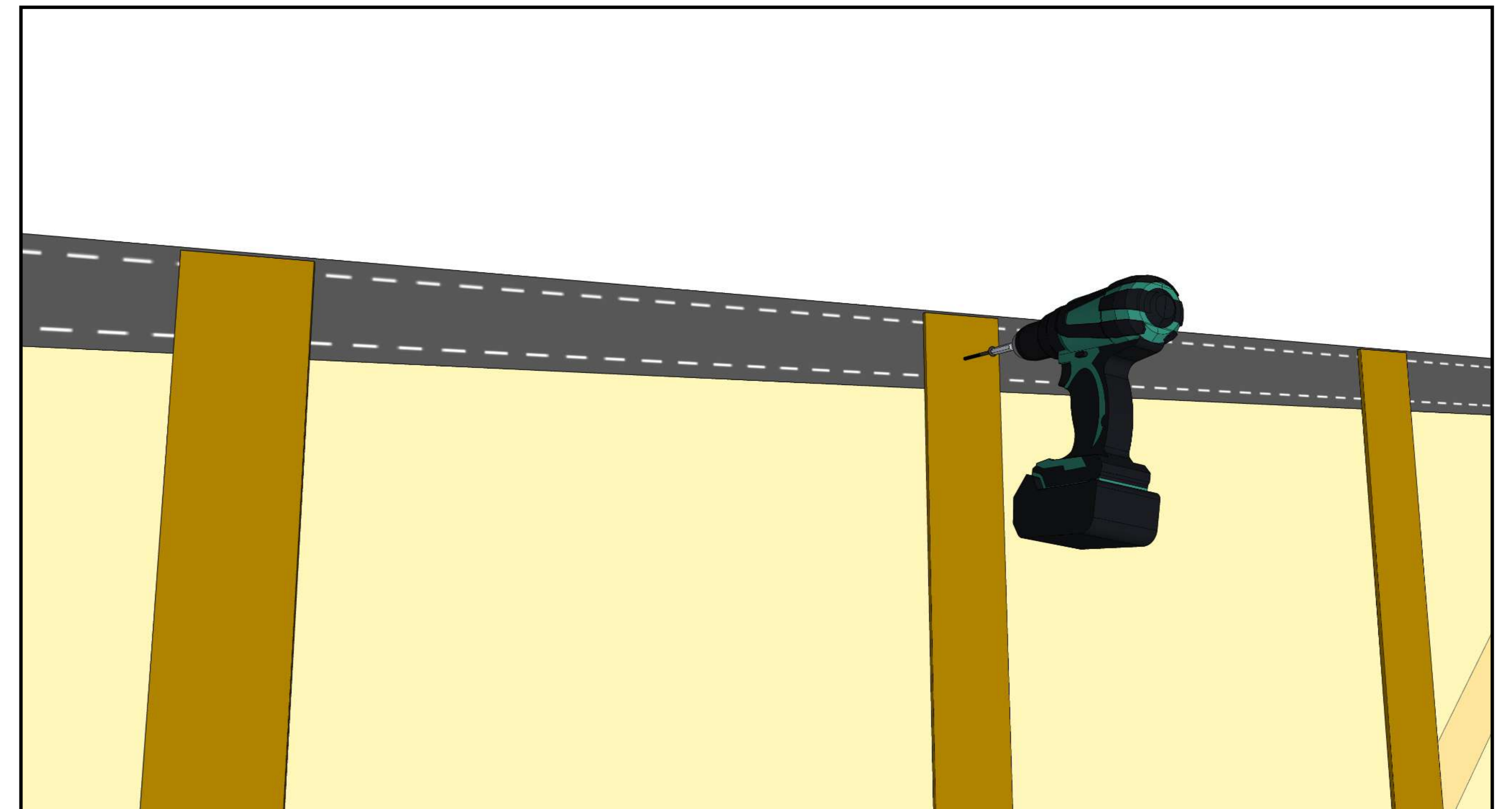

Fix the top with vertical plywood strips as well.



# Top Plate

01 **Option A**  
EPDM / Wetguard

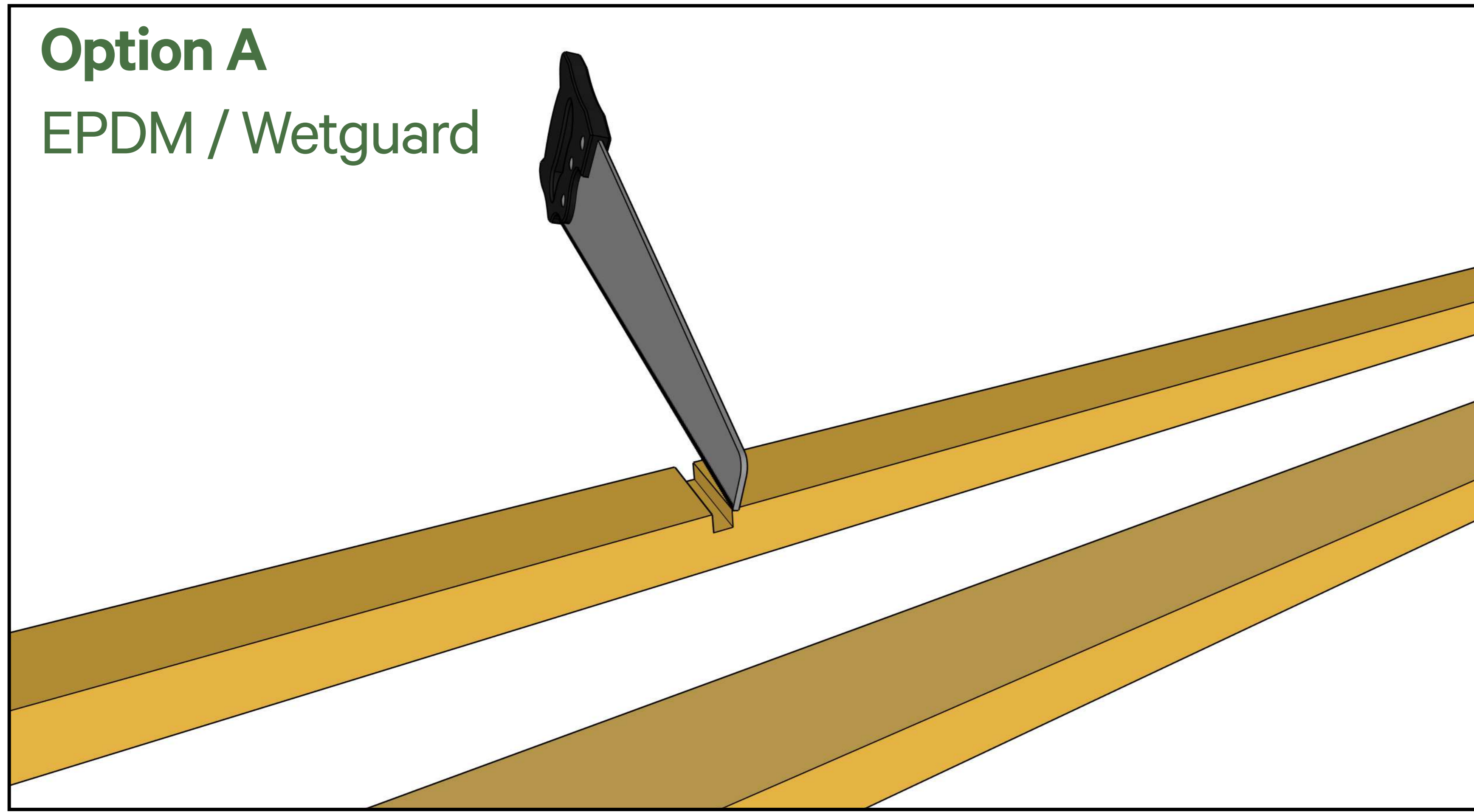

Cut 3/8 inch x 3/8 inch grooves every 3' 3" in the exterior top plate to allow drainage during construction.

02

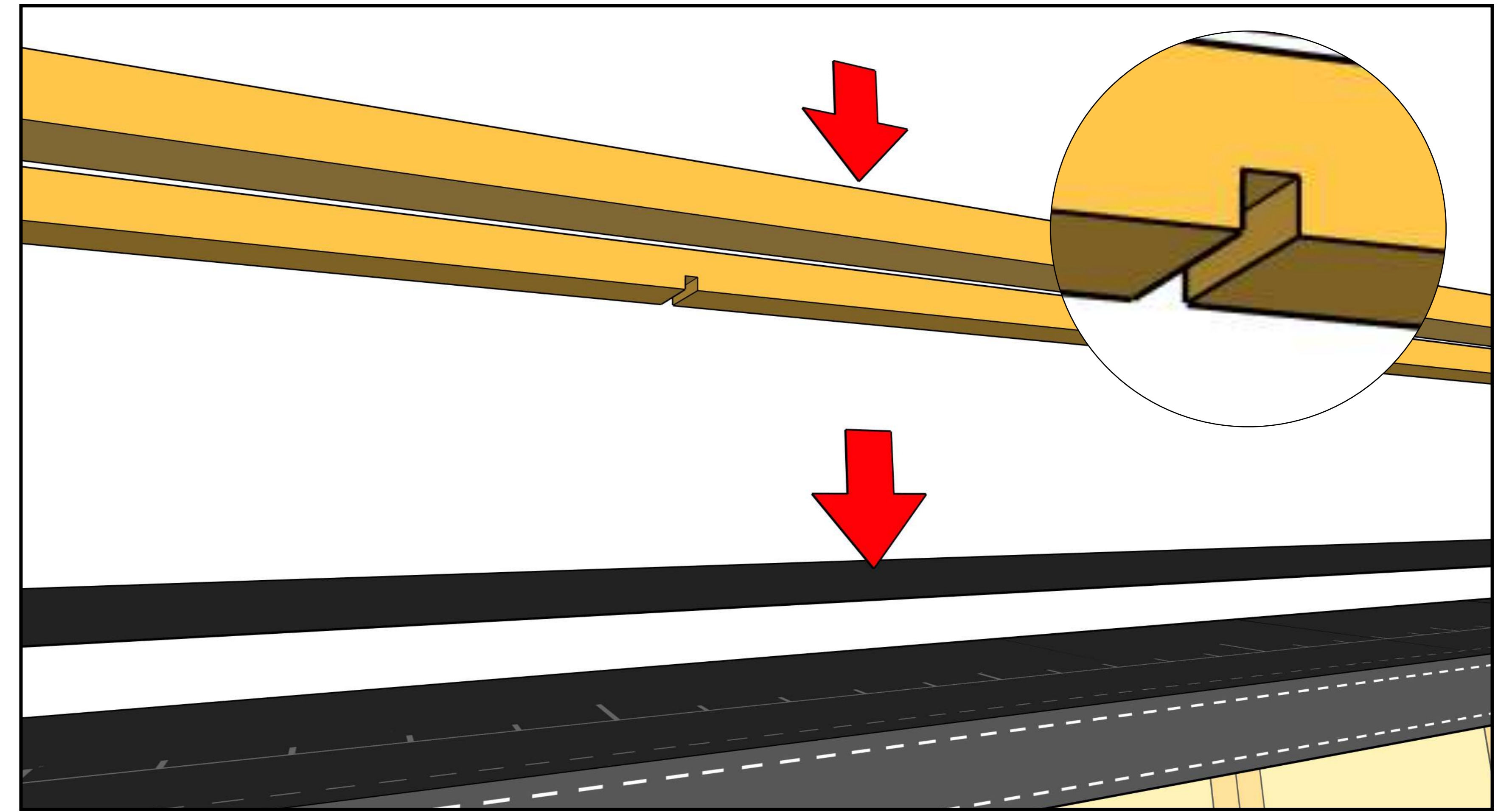

Apply EPDM strip or other weather barrier (such as Wetguard or Vista) across full panel width. Install top plate with grooves facing down.

03 **Option B**  
Foam weather strips

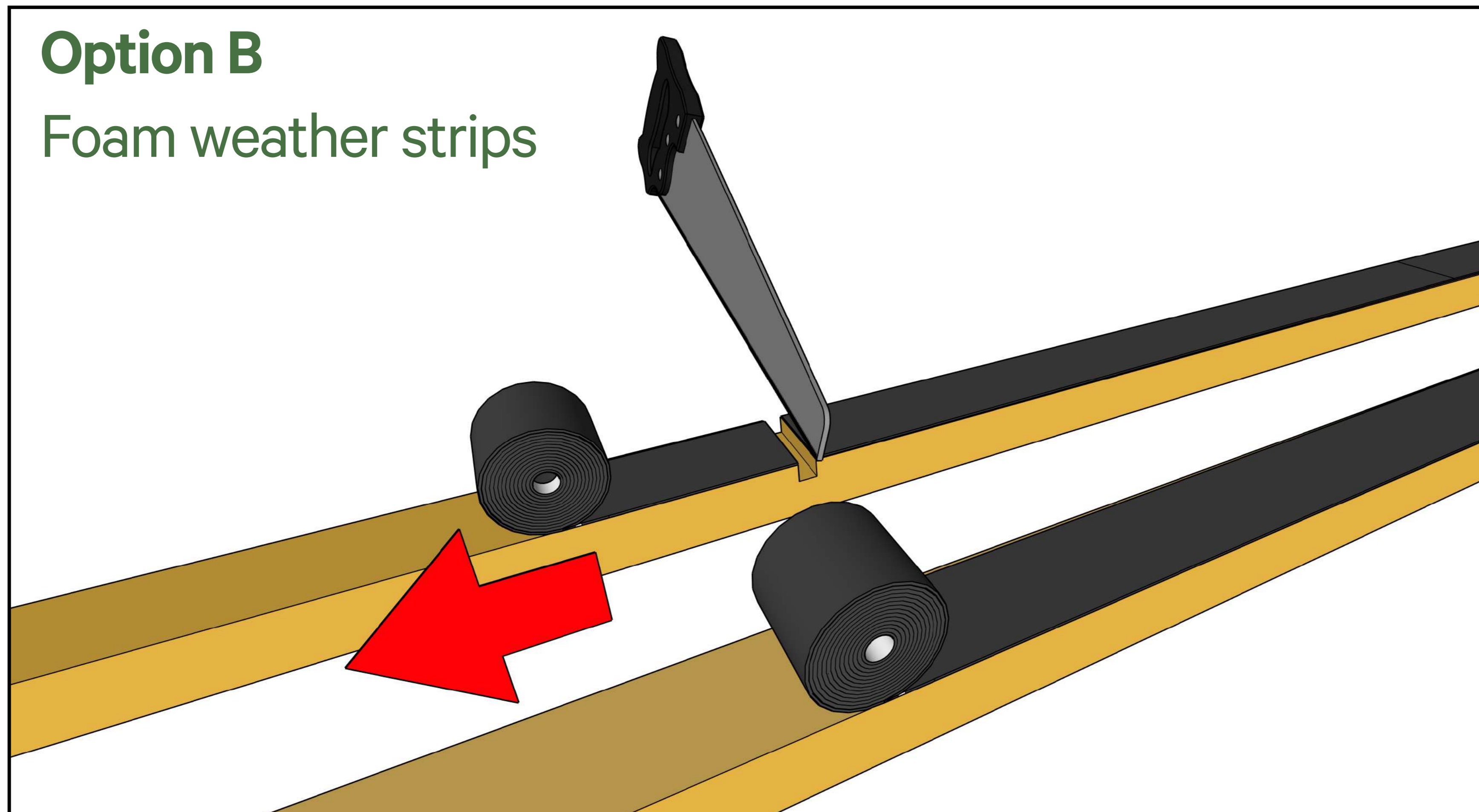

Apply a foam weather strip tape to the top plate. Cut 3/8 inch x 3/8 inch grooves every 3' 3" (for drainage during construction).

04

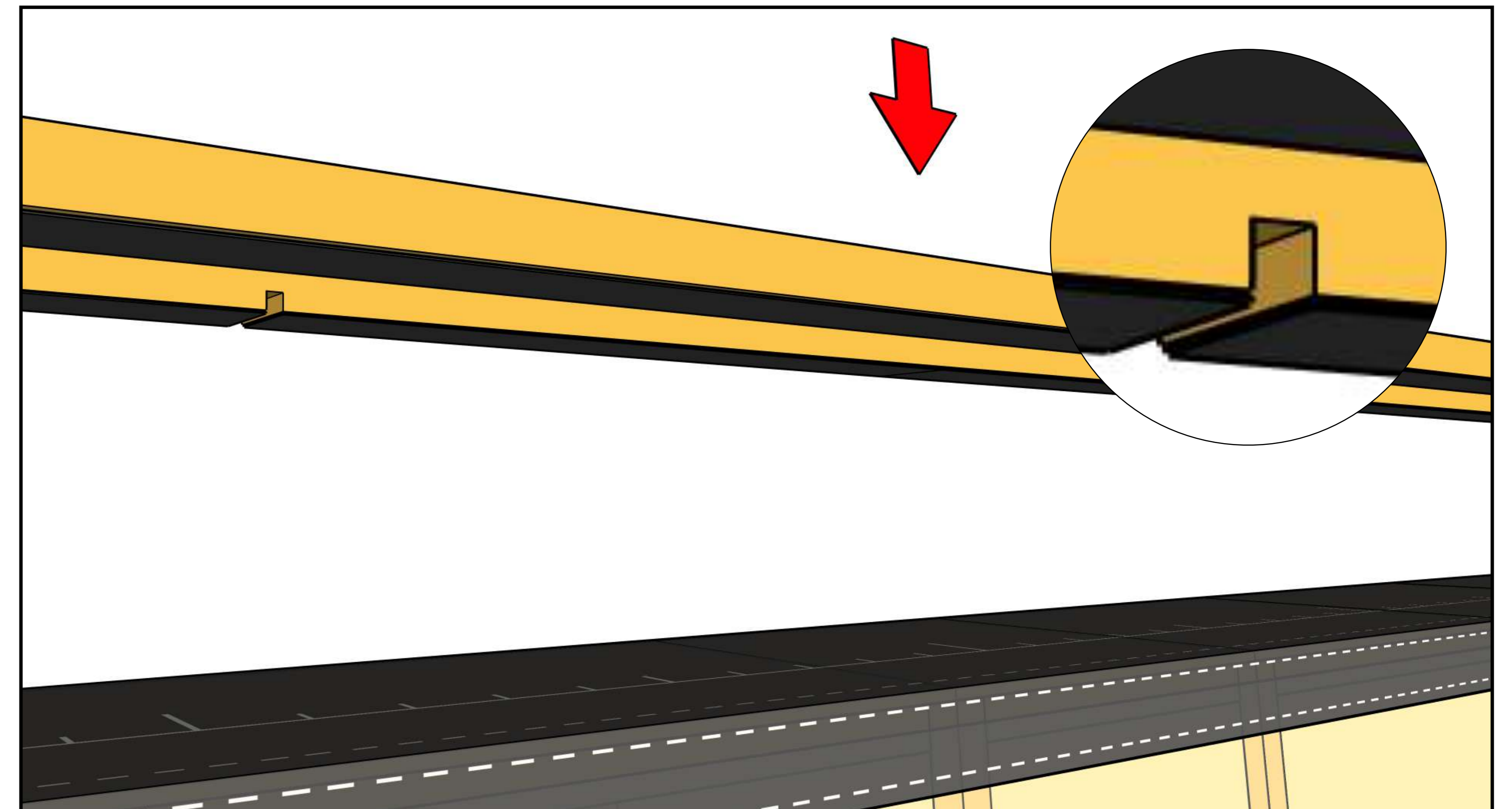

Install the top plate with grooves and foam weather strip tape down.

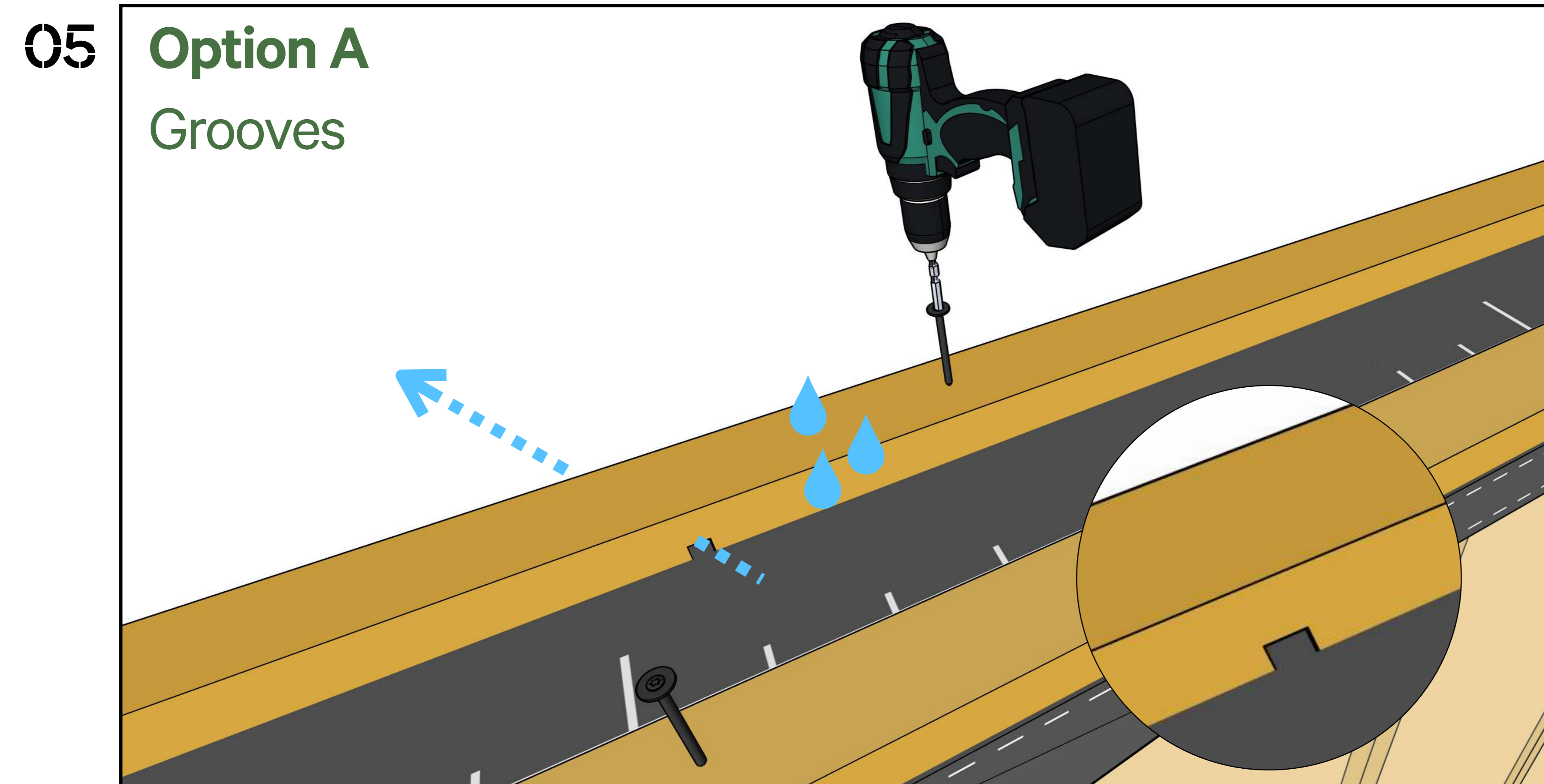

Screw the internal and external top plate with grooves into panel.

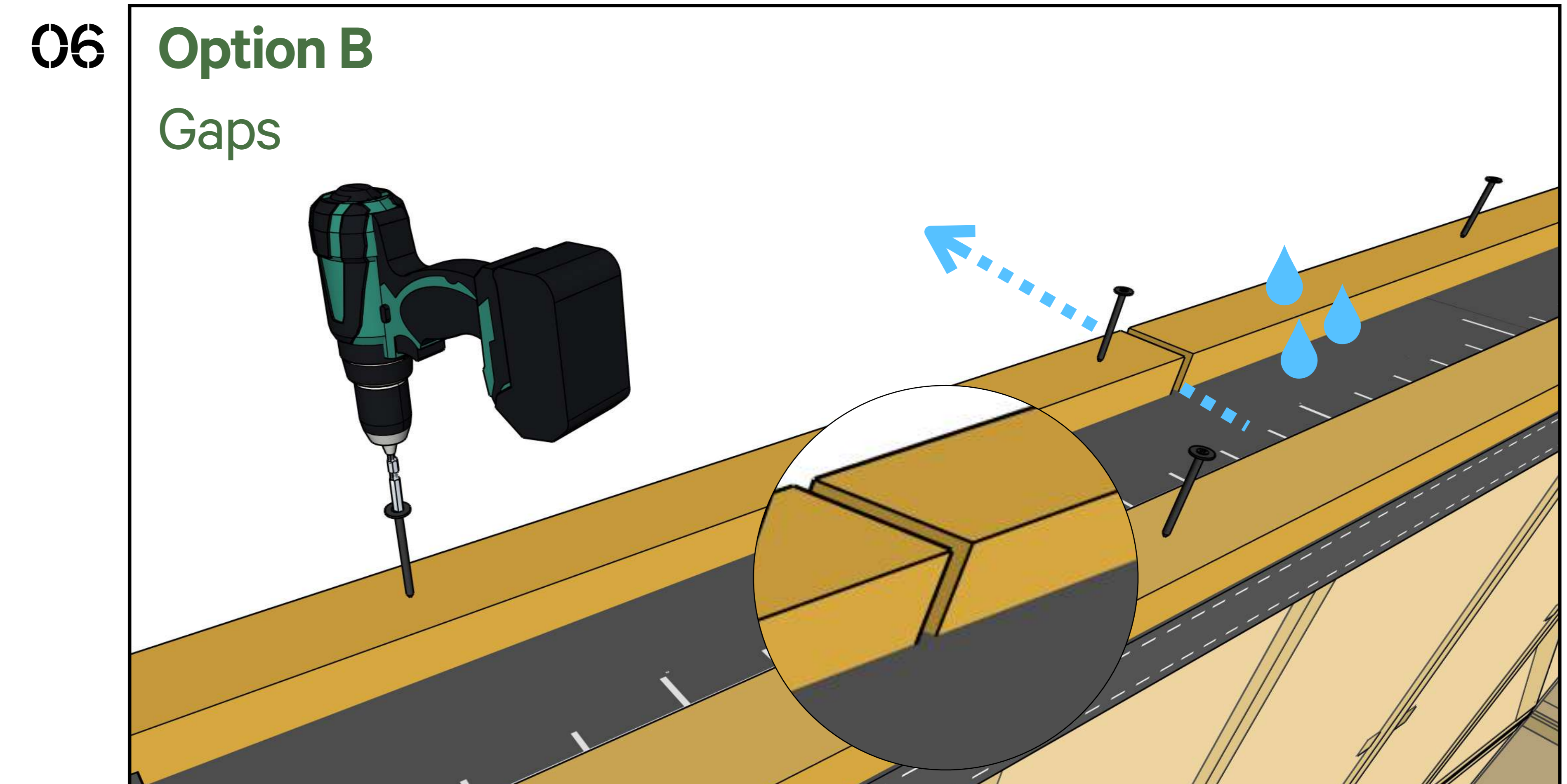

If grooves are not cut, leave regular gaps between exterior top plates to allow rainwater drainage during construction.

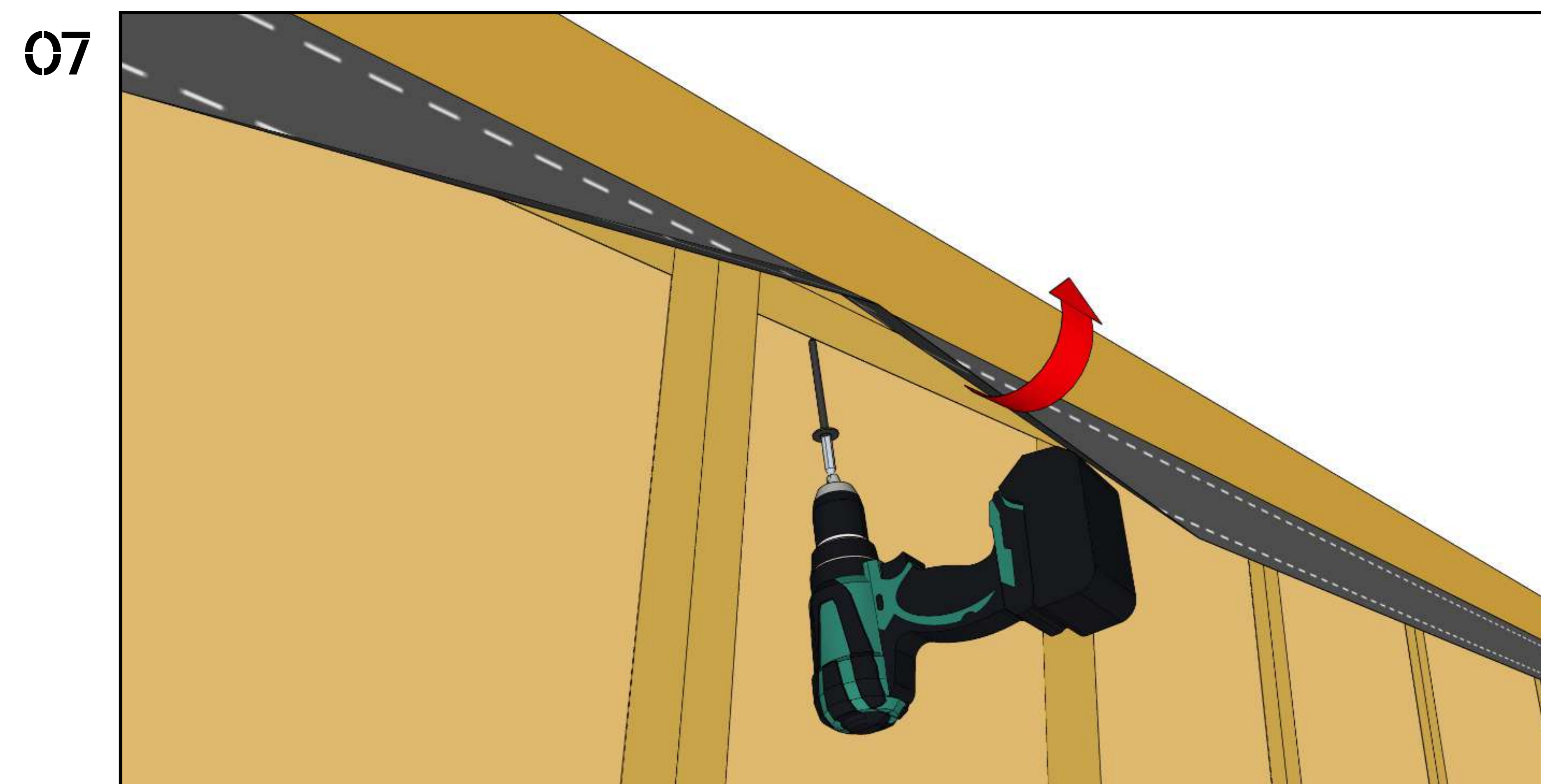

If the top plate is thick, screw it from the bottom through panel to wood.



# Straw Wall Penetrations

01

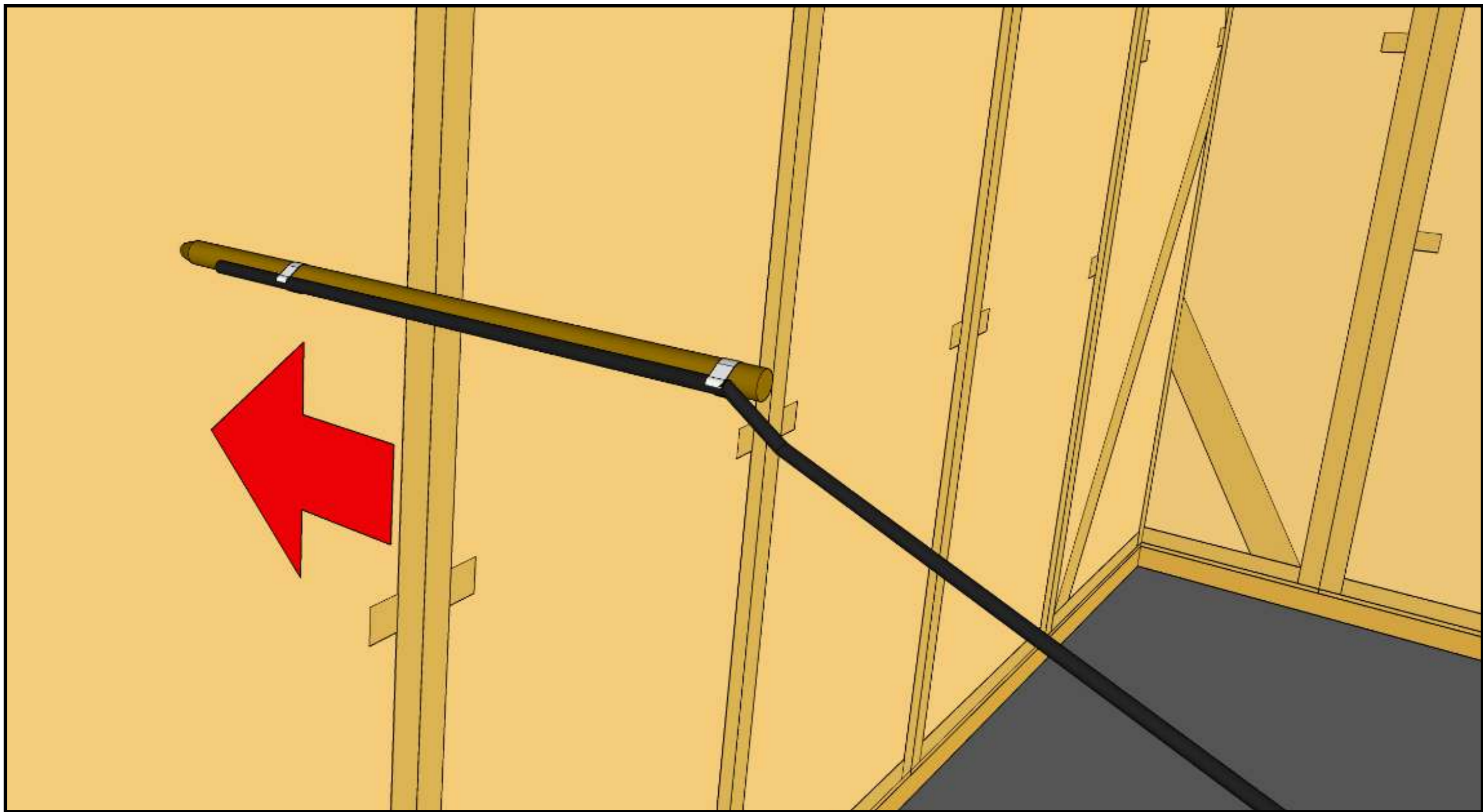

Small diameter cable can be pulled through using a thin stick.

02

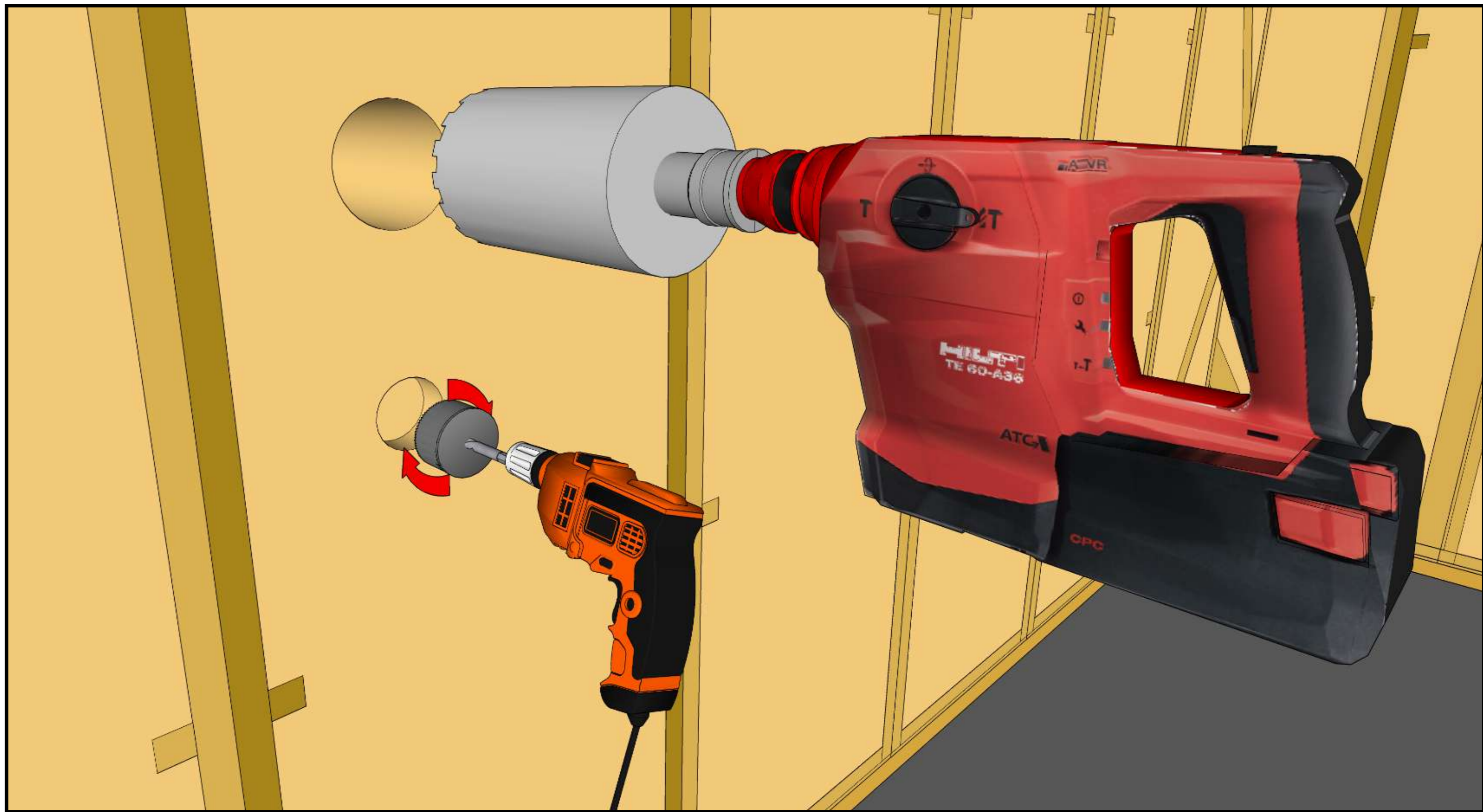

Larger diameter pipe can be drilled with a diamond drill on site or panels can be delivered with predrilled holes.

03

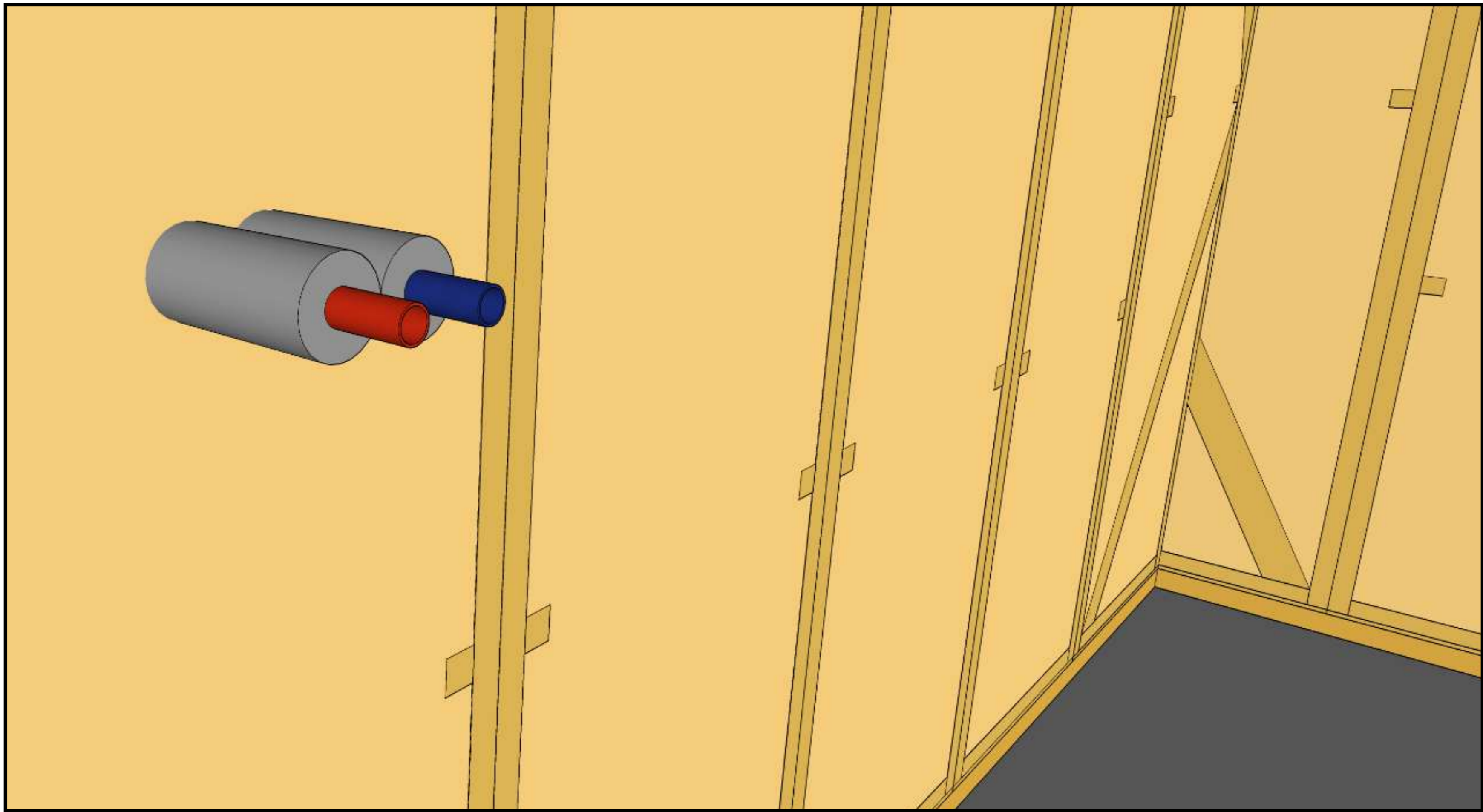

All hot and cold pipes need to be insulated according to regulations. Use closed cell insulation to mitigate any condensation risks.

04

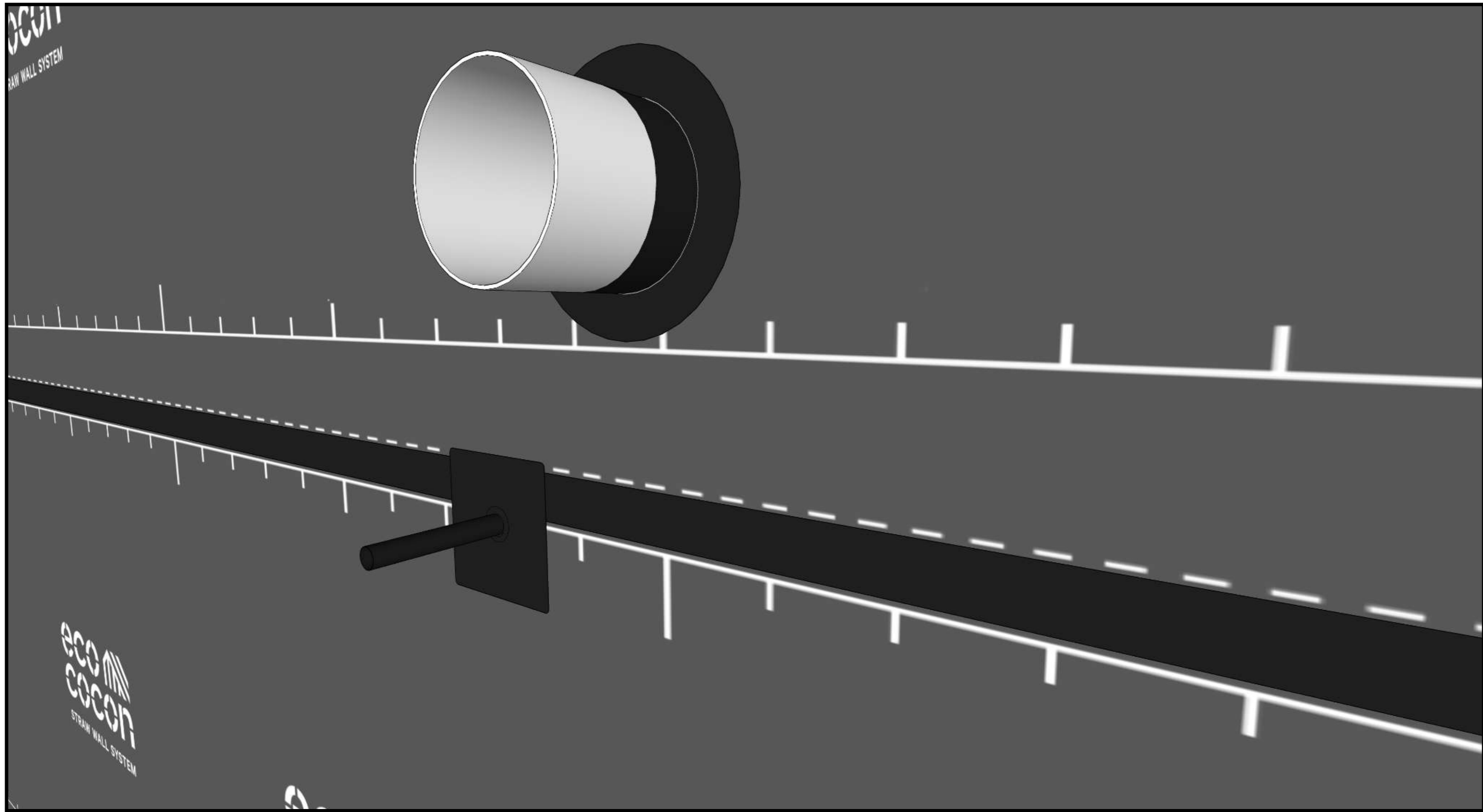

Cables and pipes need to be airtight sealed to the membrane on the outside.



05

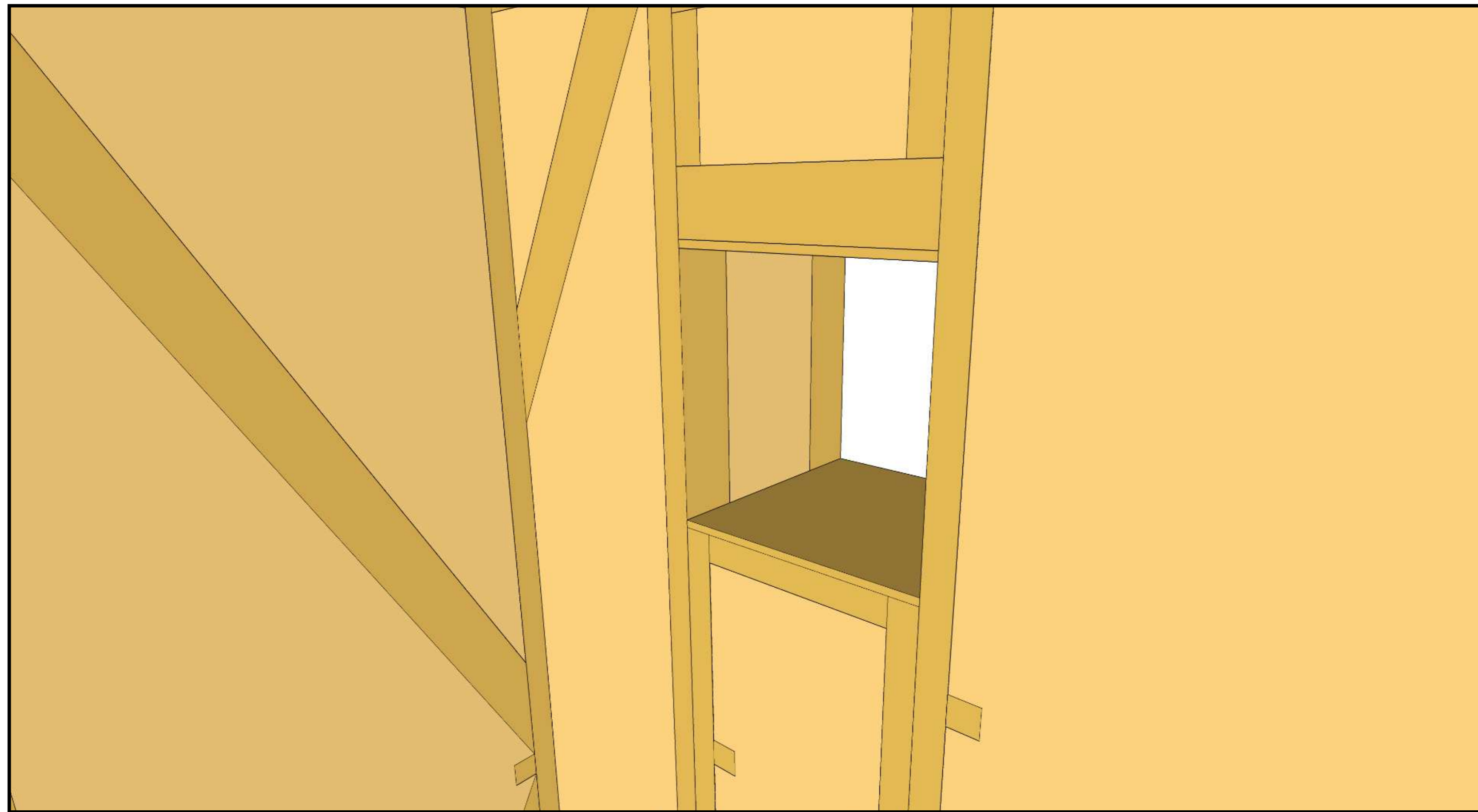

Smoke ducts/chimney or ventilation ducts need a bigger hole, which should be considered in the Panel Project and made in production.

06

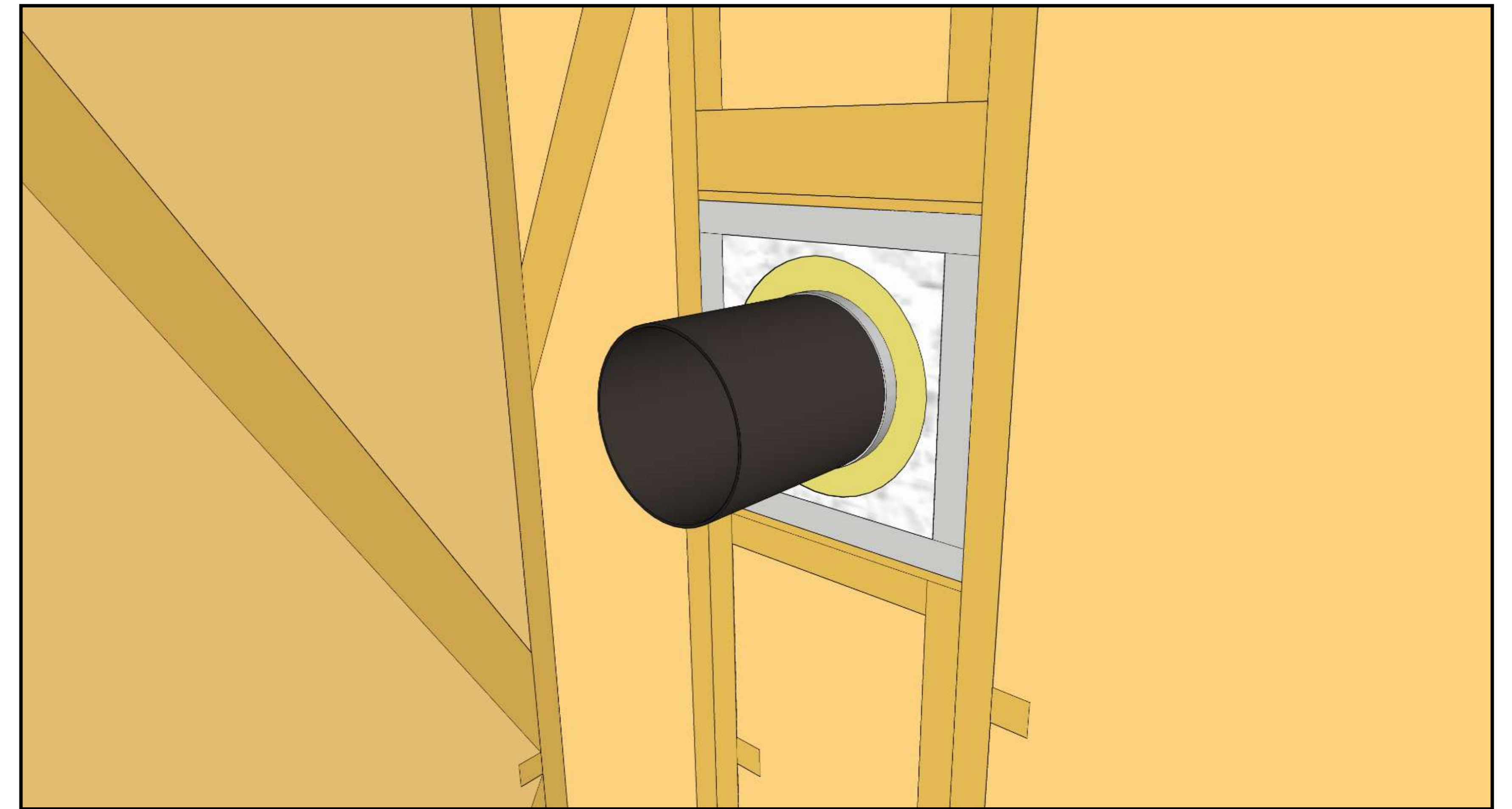

Smoke ducts/chimney have to be surrounded by fire resistant material in compliance with National Regulations.



Smoke ducts/chimney installation must strictly follow National Regulations



# Window and Door Installation

01

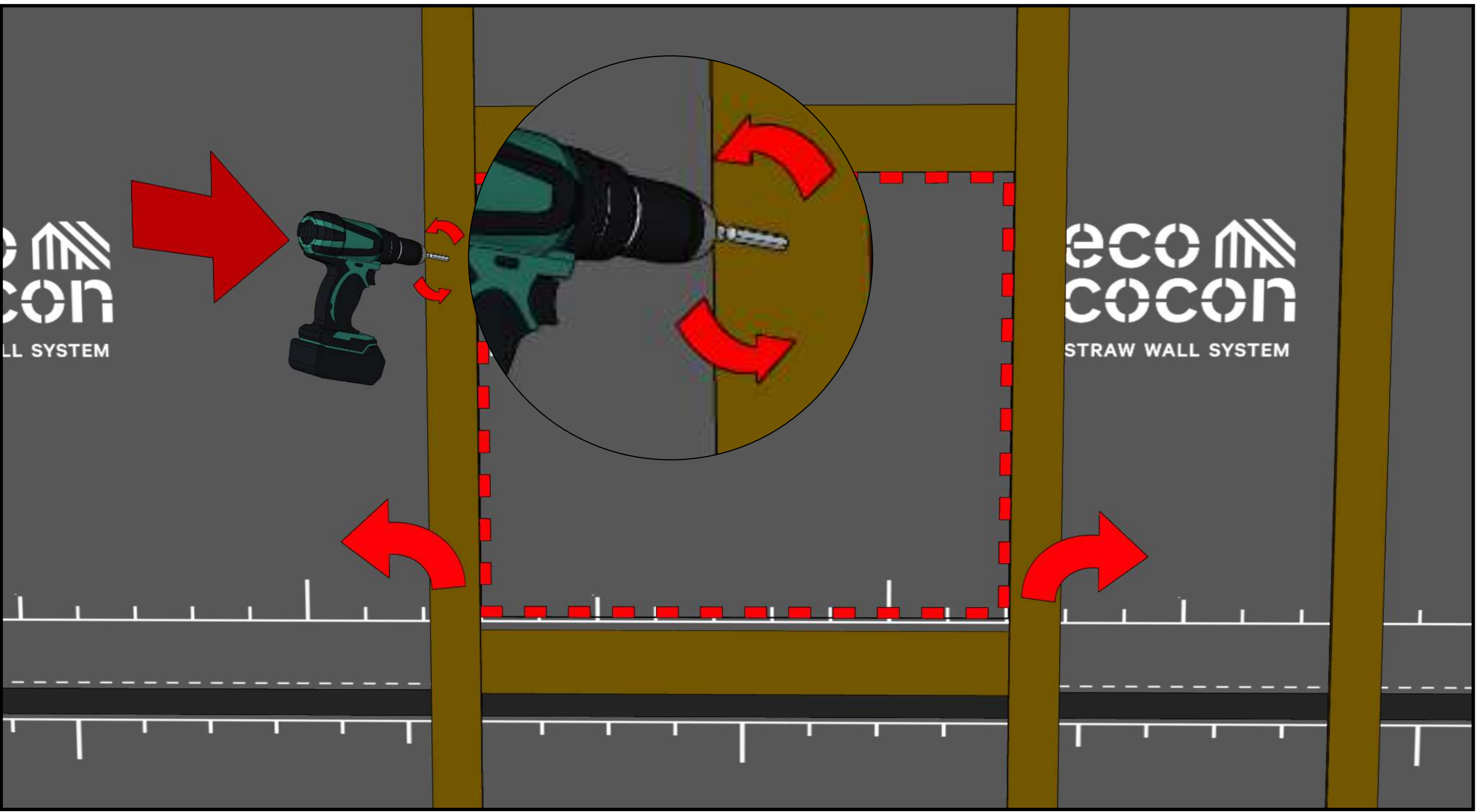

Unscrew the plywood strips around the opening.

02

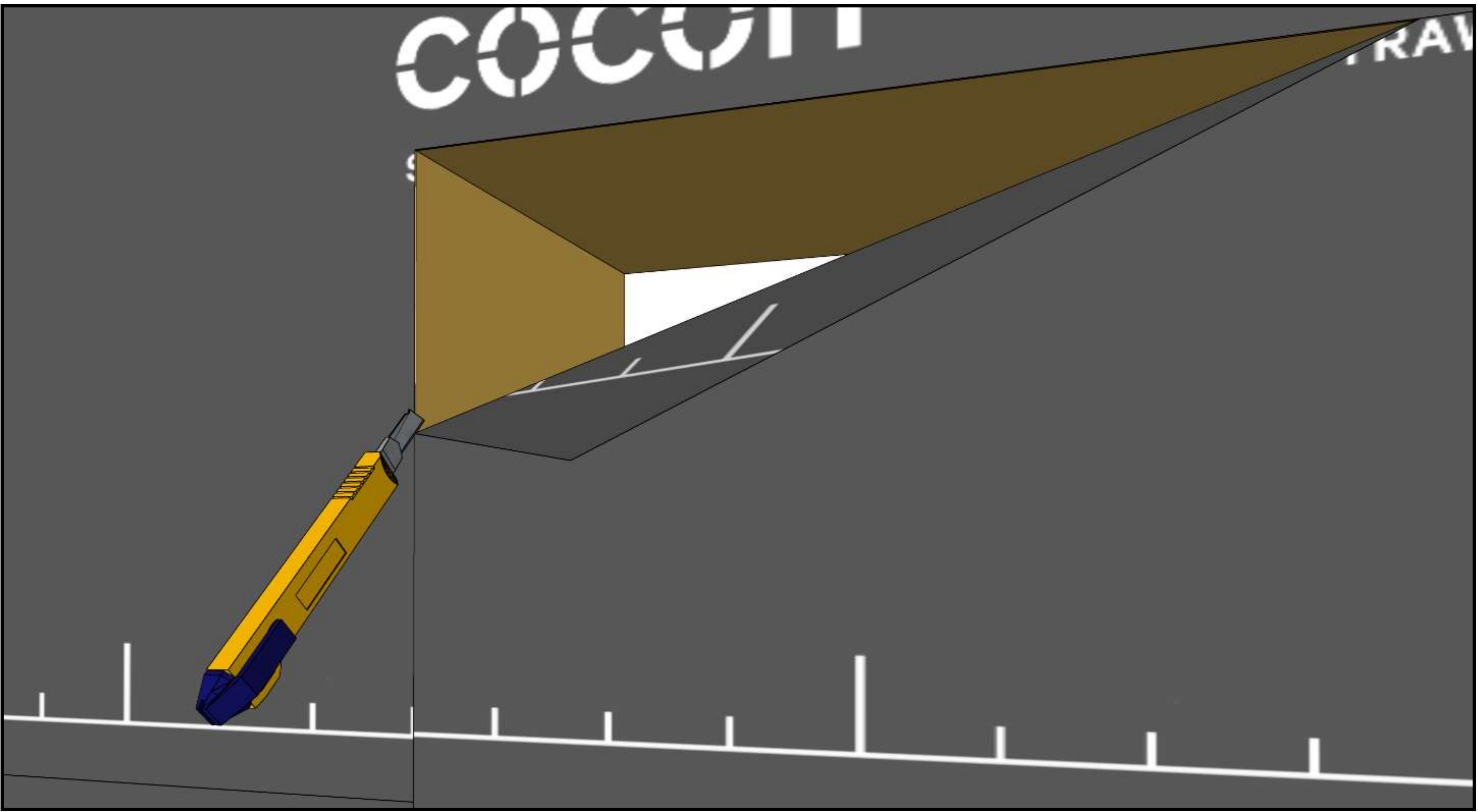

Cut the membrane according to the wall opening.

03

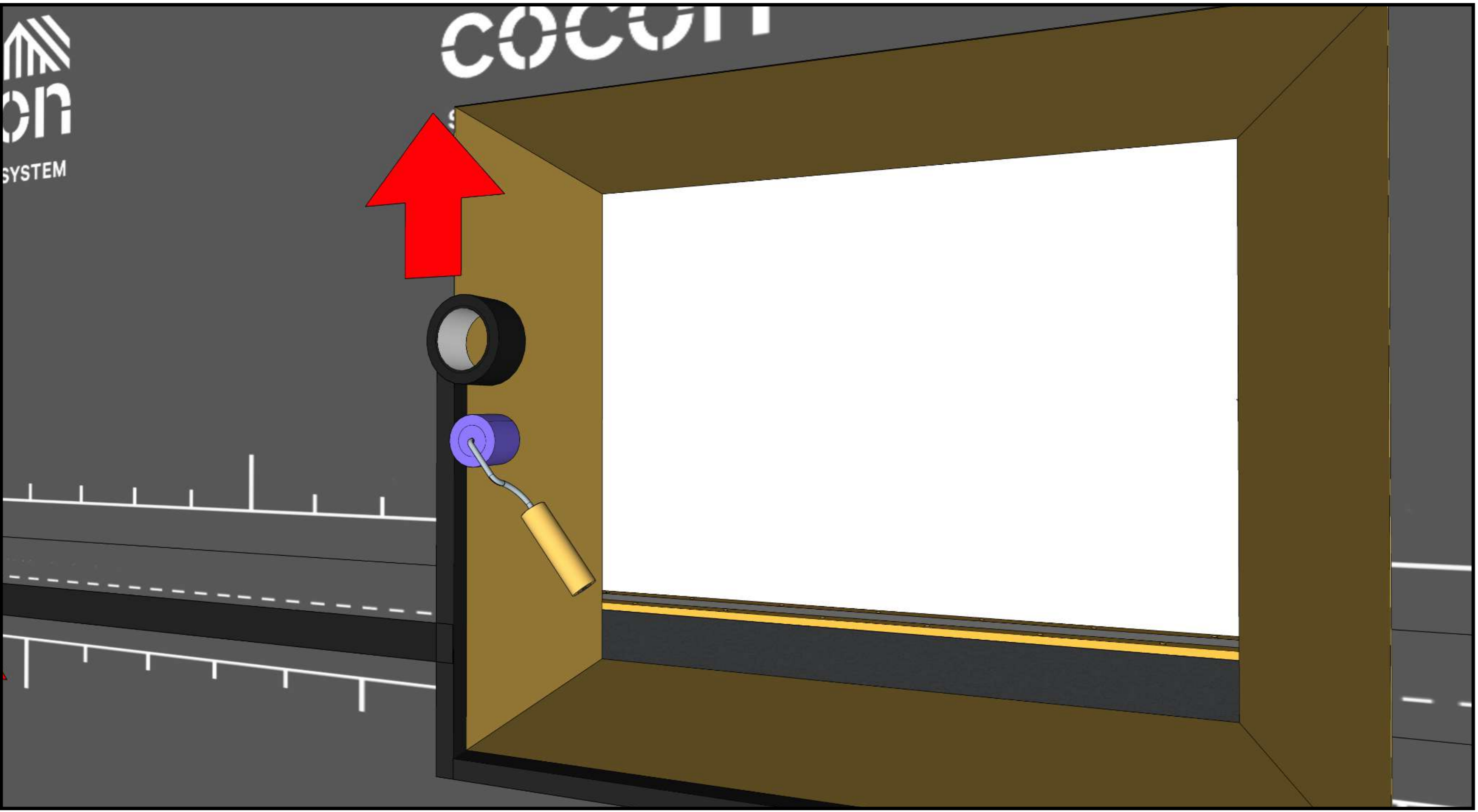

Tape the membrane to the plywood reveals and press the tape with a roller - pressure ensures strong adhesion.

04

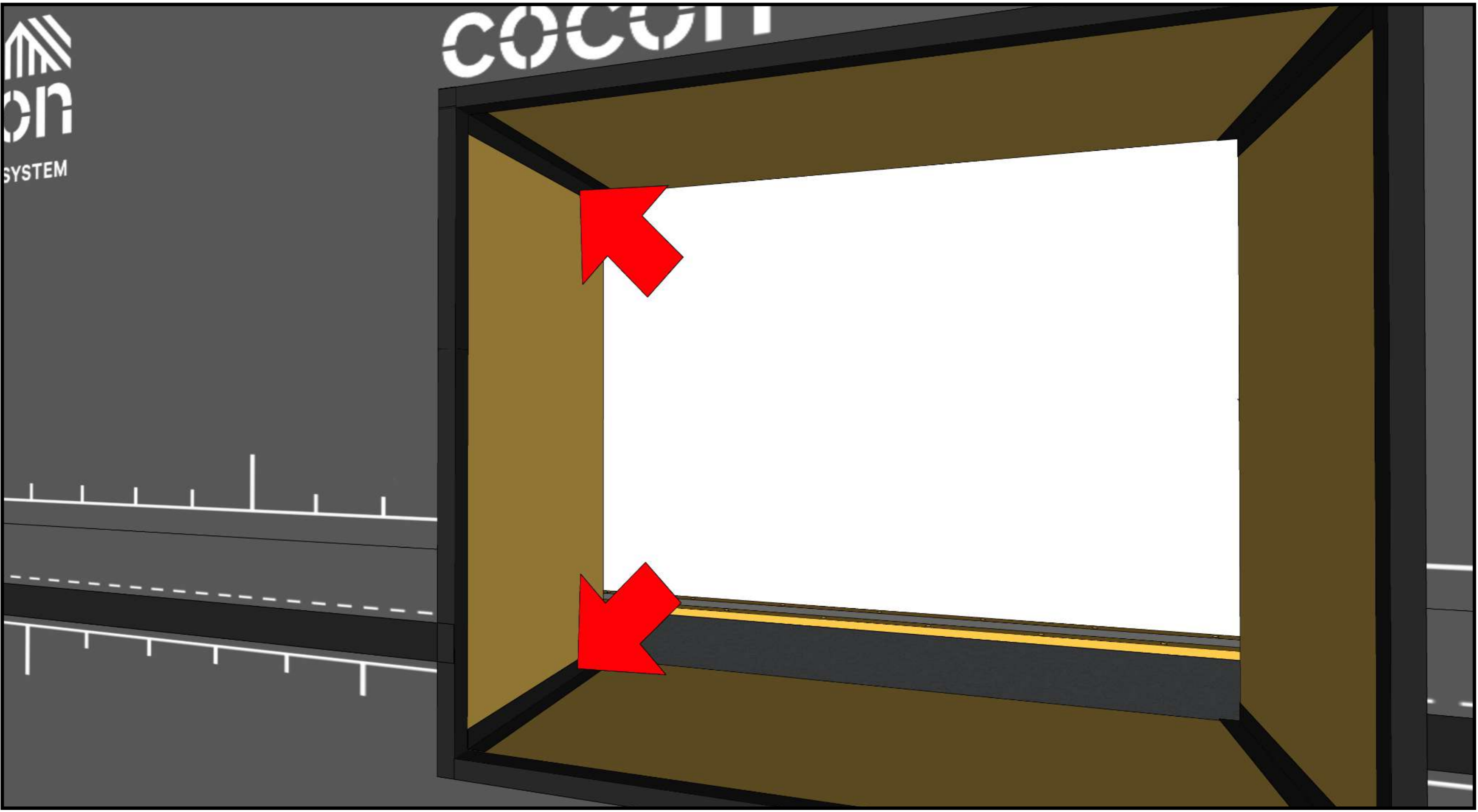

Use an airtight tape to connect the plywood reveals to the lintel and sill.

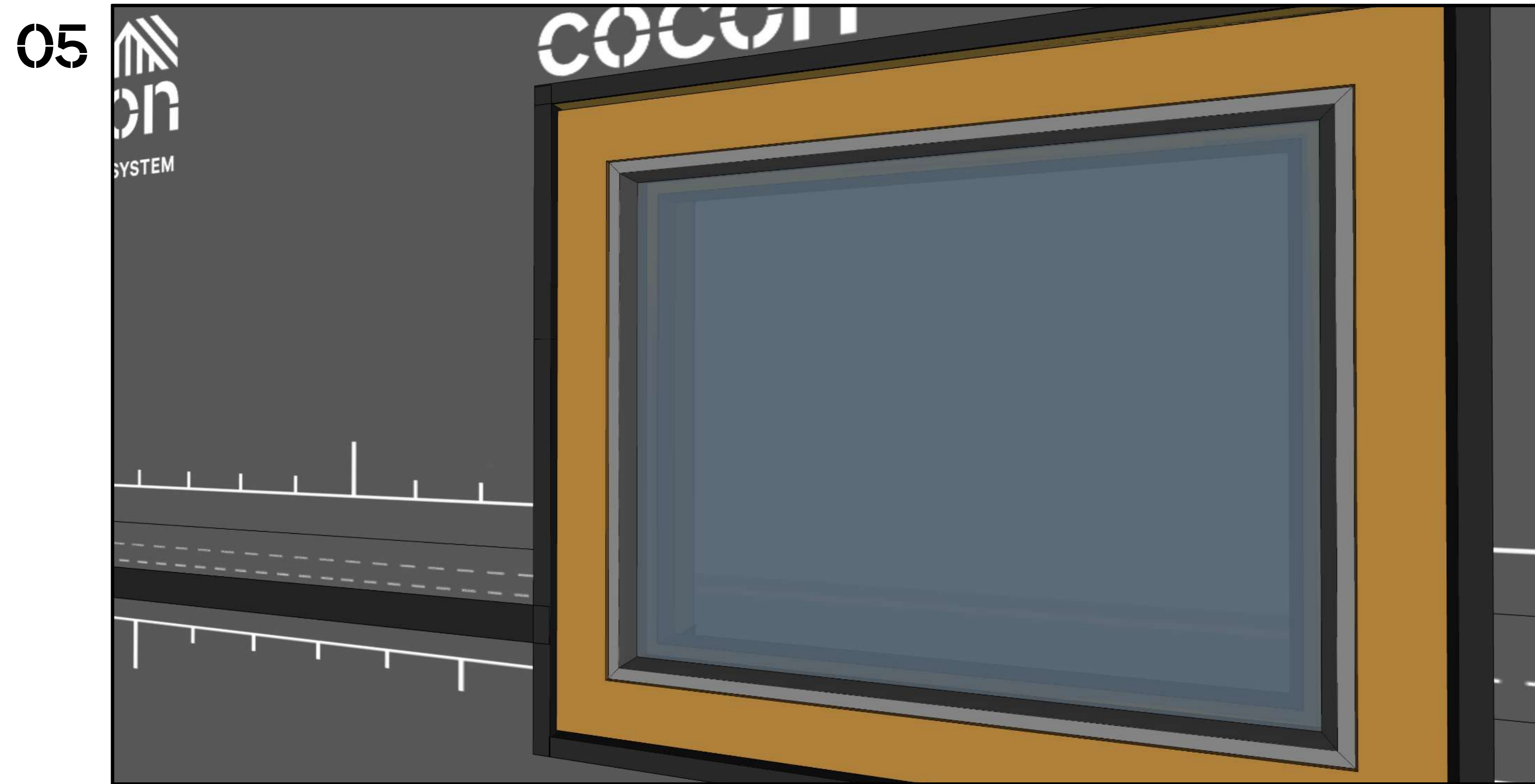

Mount the windows and doors according to the schedule and manufacturer's technical guide.

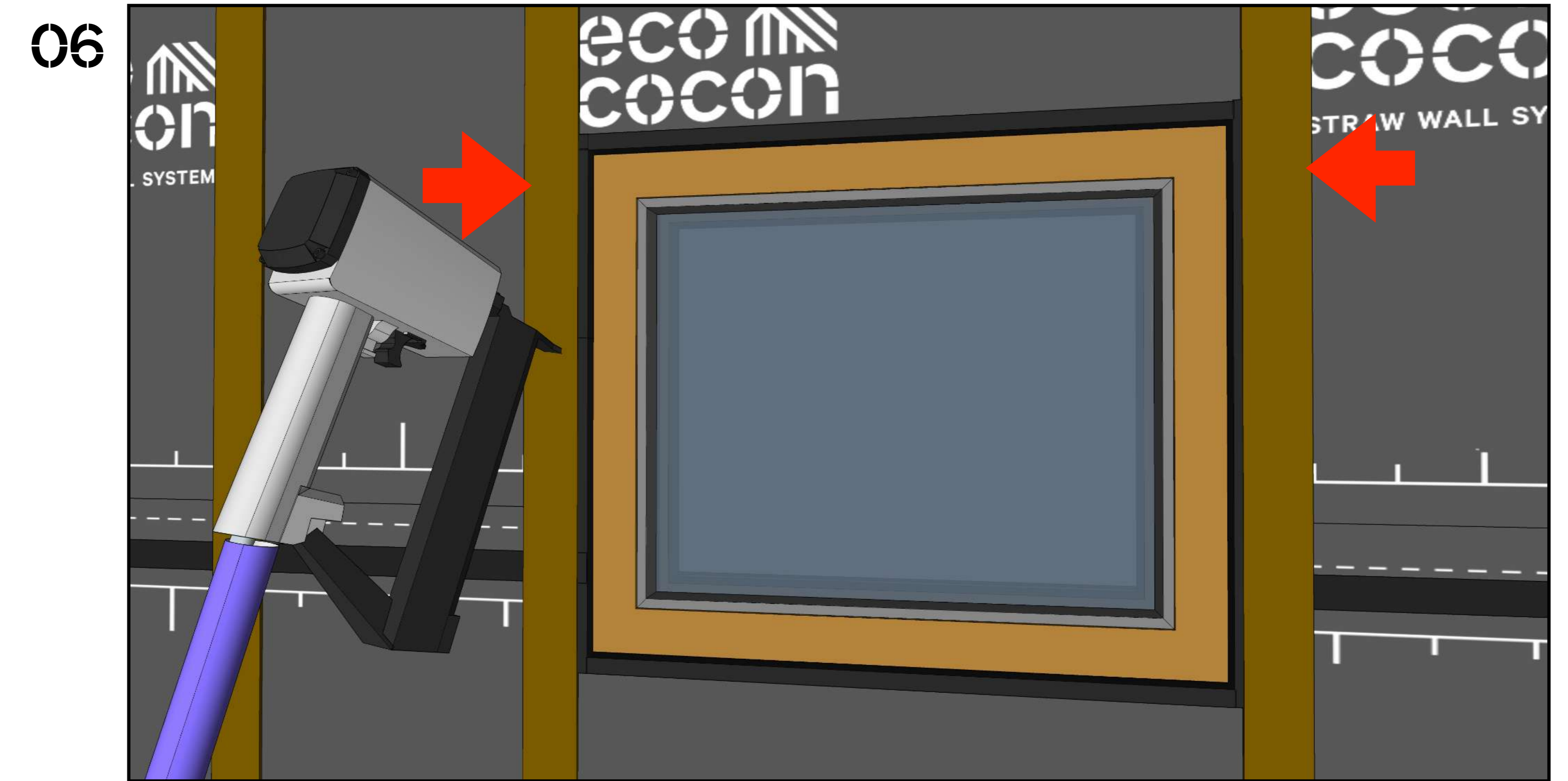

Staple/screw plywood strips back on vertical posts around the opening.

# Wood Fibre Board

01

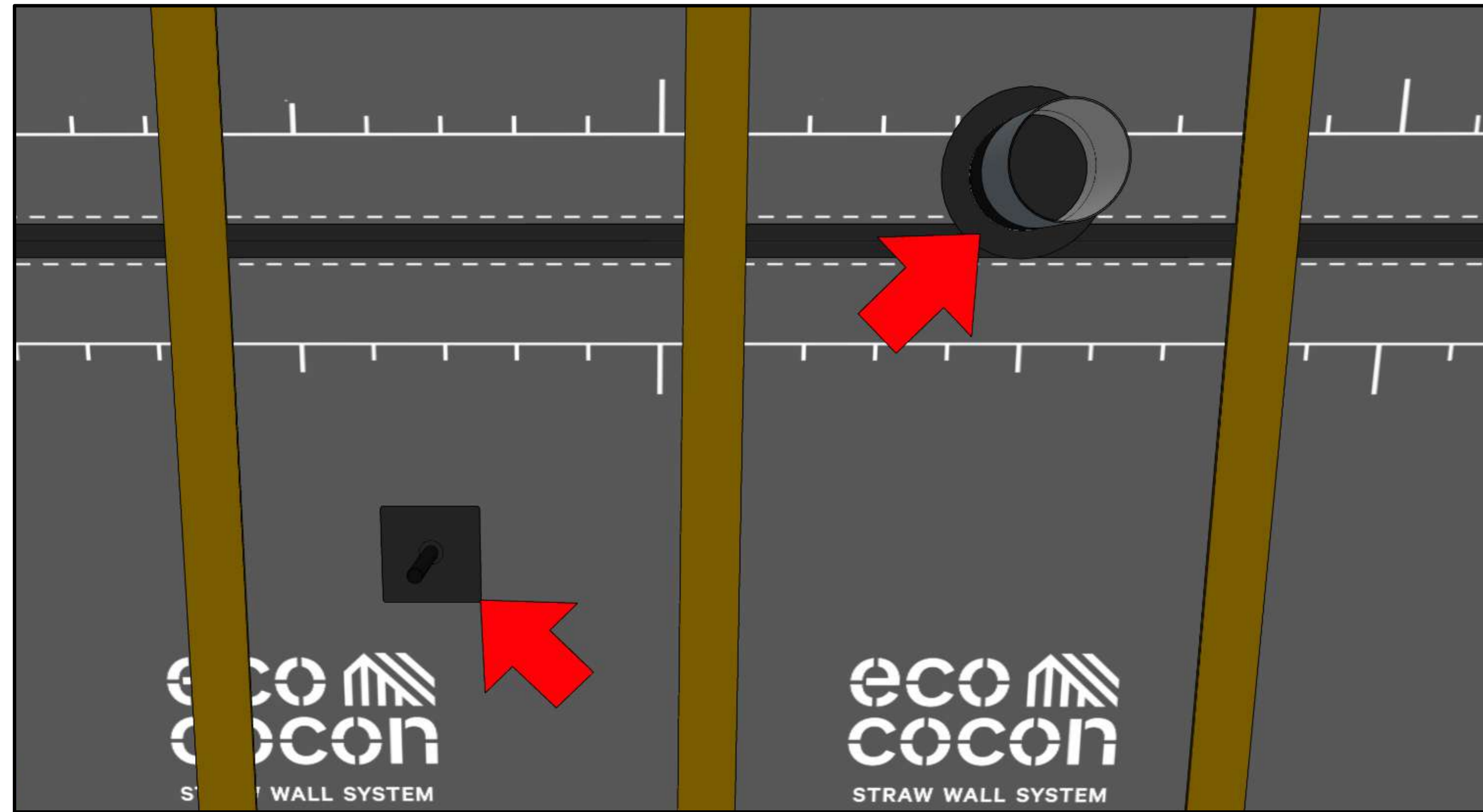

Ensure that airtightness is complete and any installation penetrations through the membrane have been sealed and are airtight.

02

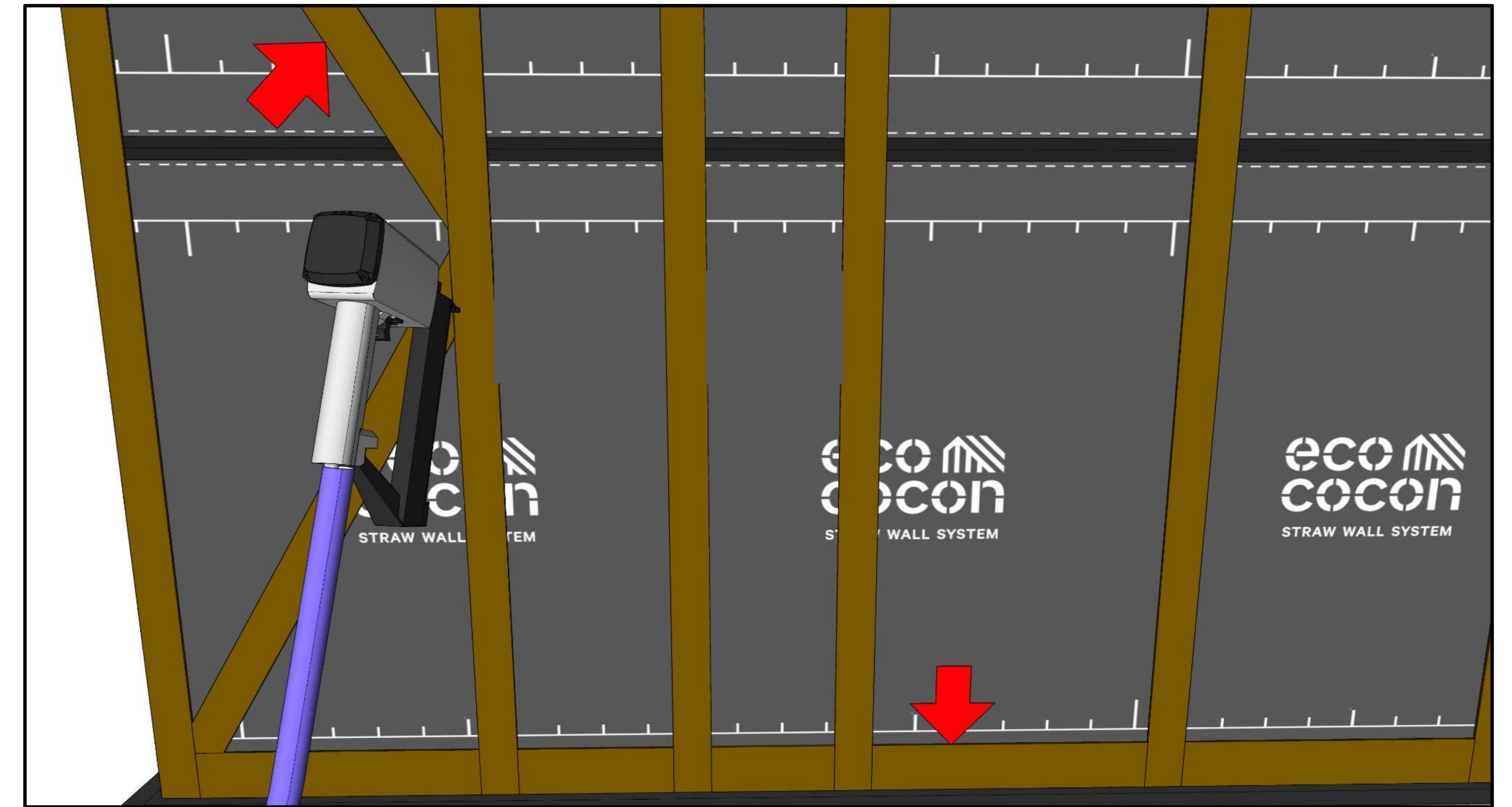

Fix diagonal and horizontal plywood strips onto the timber construction shortly before mounting the fibre board.

03

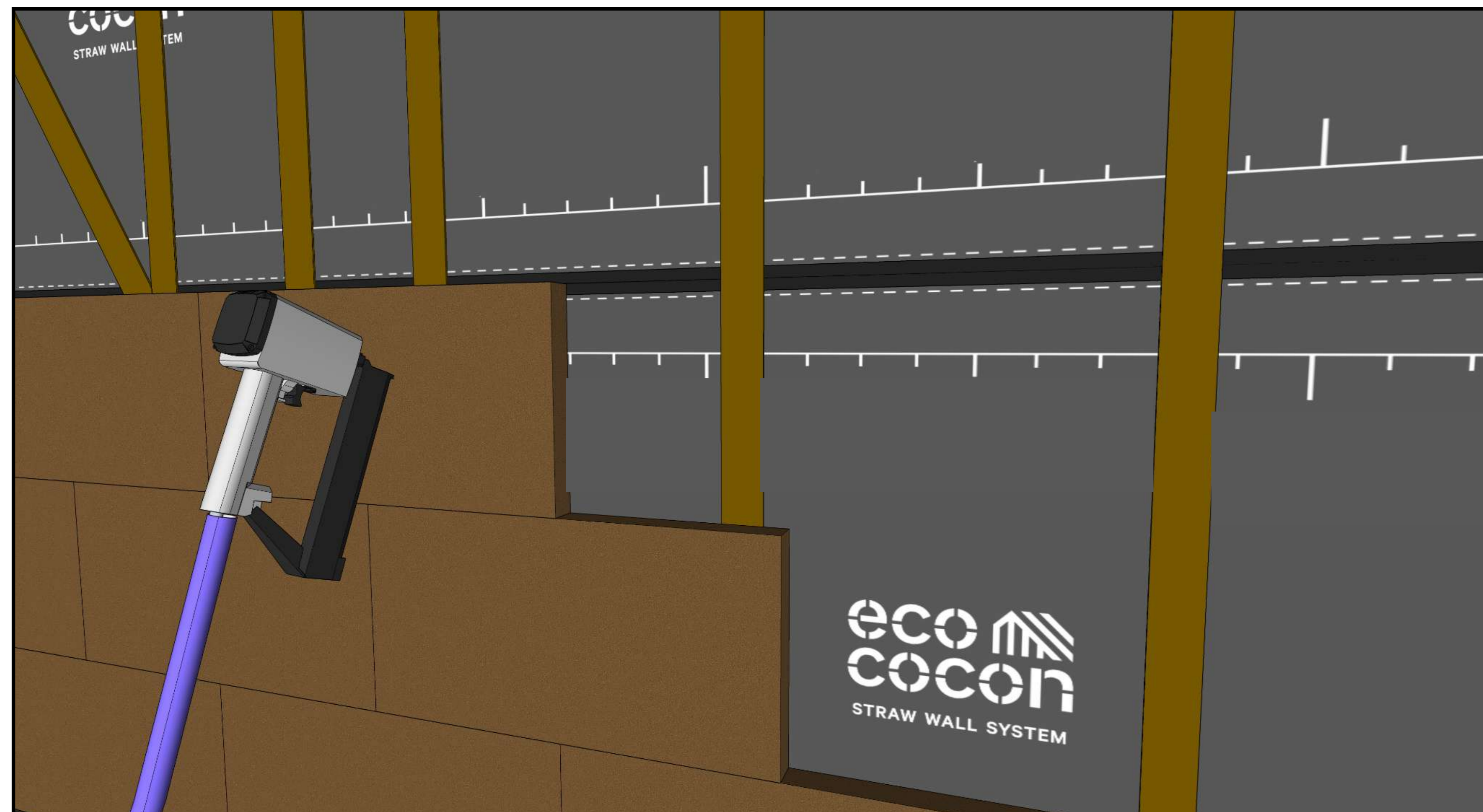

Nail/screw the tongue and groove fibre boards to the timber frame of panels. Refer to the assembly guide of the fibre board producer.

04

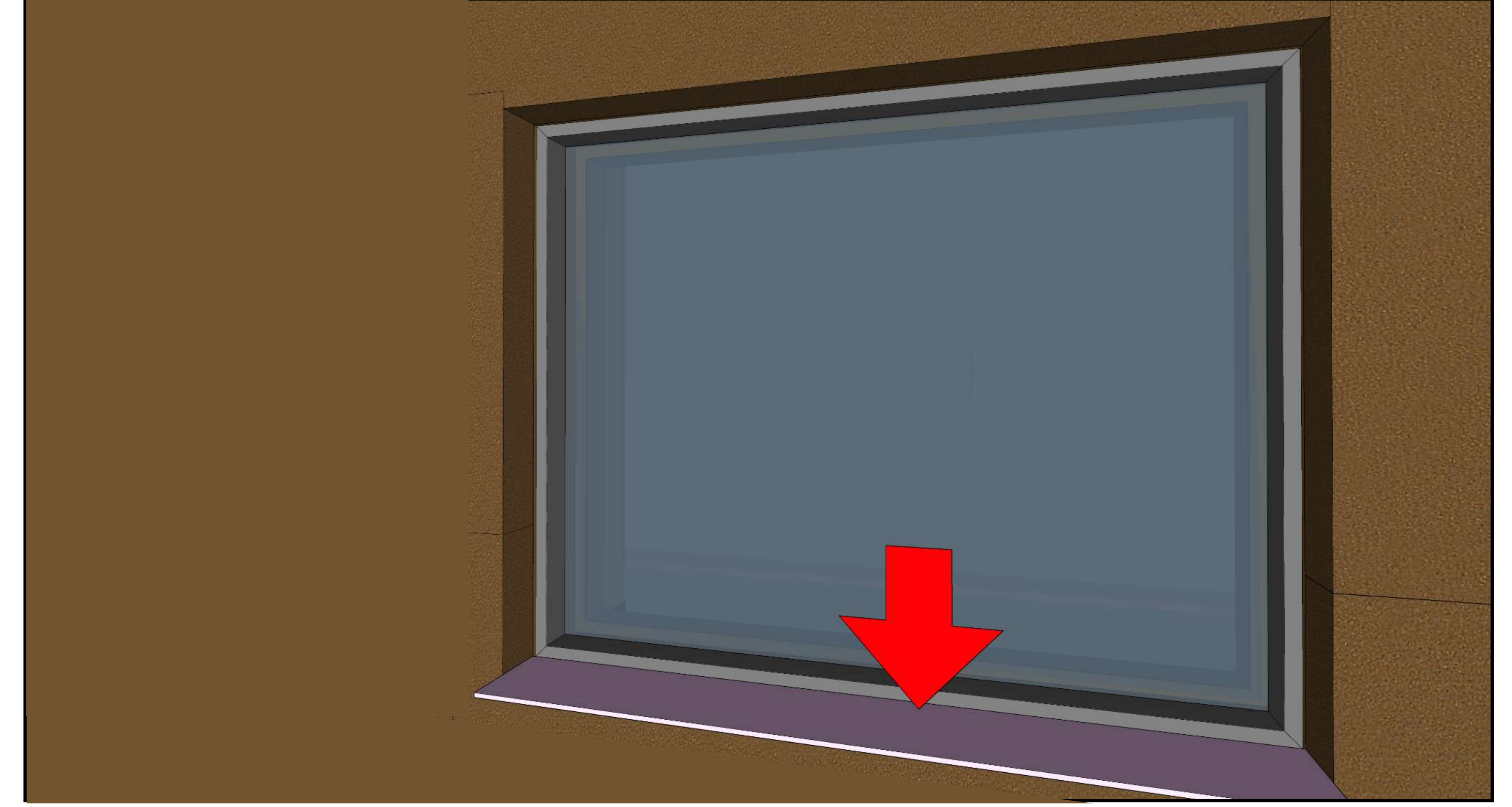

Protect the gap between the board and the panel against rain/water before you mount the window sill.

# Connecting Partitions to Wall

01

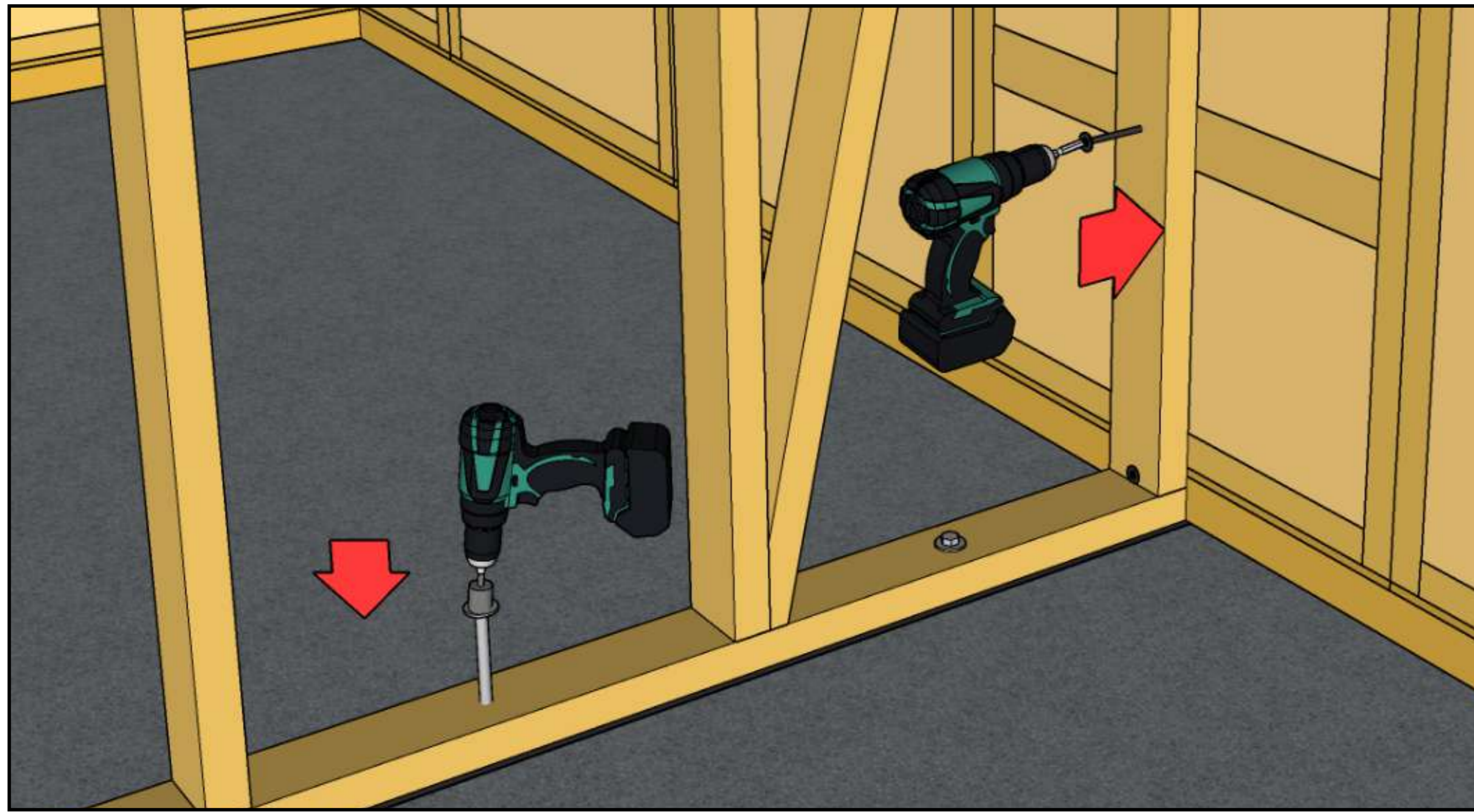

Fix the partition to the intermediate horizontal battens of the panel structure.

02

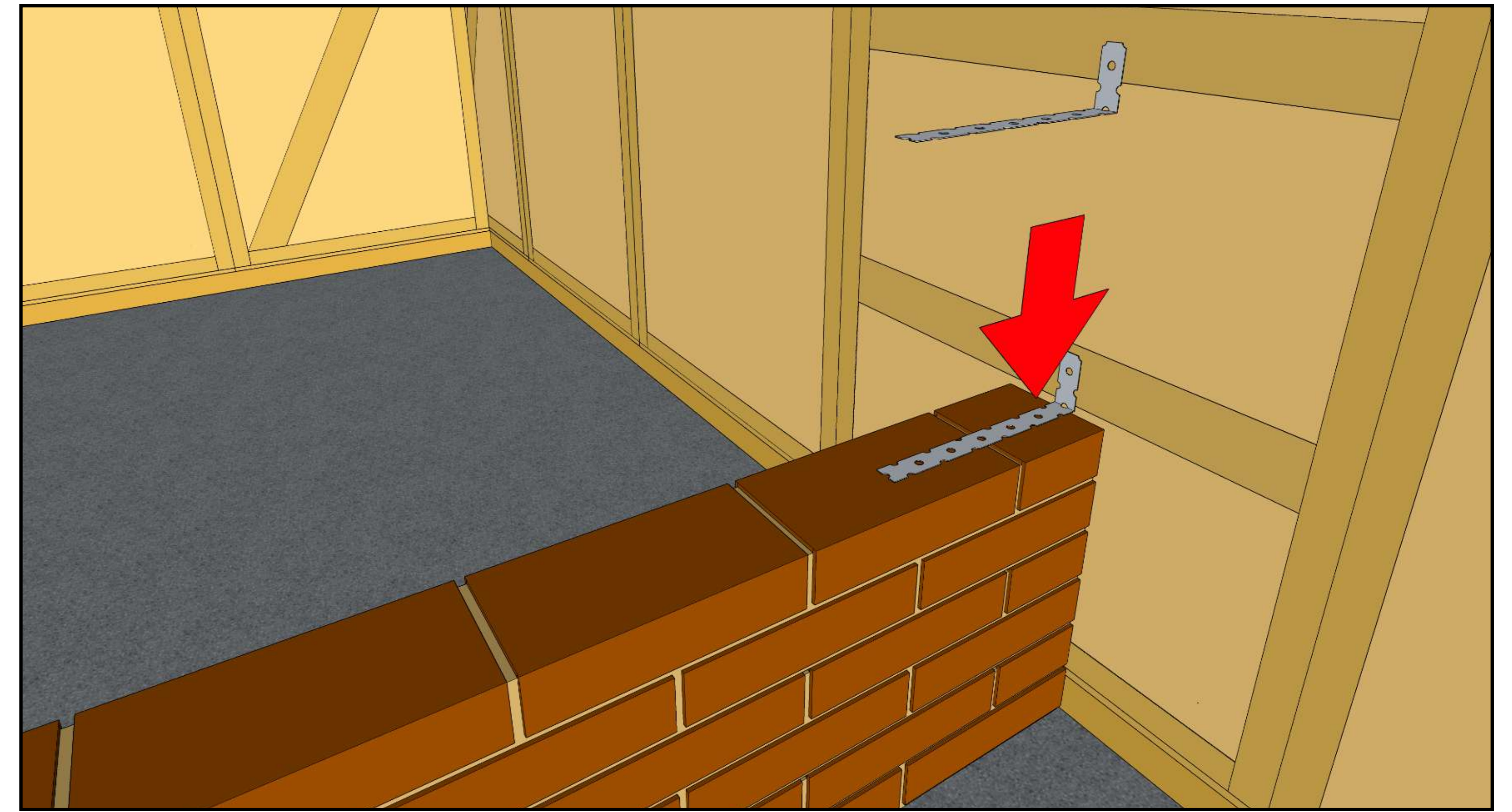

Fix a masonry partition to the intermediate horizontal battens of the panel structure.



# Interior Installations



# Rules and Recommendations



Installations must strictly follow National Regulations.

## Drilling into timber structure

If you need to drill a hole in a stud or create a recess for electrical conduit, it's important to consult with an EcoCocon structural engineer for the project.

## Plumbing

- » Do not mount the plumbing directly in contact with straw. Use a water resistant board (plywood, gypsum fibre boards, OSB) on the walls where the services and plumbing will be installed.
- » A service void is recommended to install plumbing services.

## Electrical installation

- » For electrical installation must strictly follow National Regulations.
- » Electrical wiring can be fixed to studs or straw before plastering. Most countries require protective conduit (Metal-Clad cables in the US). Some countries prohibit direct fixing to studs to prevent damage from future installations.
- » An installation void can be utilized universally.

## Surfaces and connections

- » Do not leave straw uncovered. Use plaster or mount boards for fixing the services, but cover the whole straw surface including behind the service void, at edges, above the ceiling, etc.

- » Mount any rails needed for skirting board or installing a gypsum board system (timber or plastic) prior to plastering. Plastic rail is recommended for creating neat edges and connections.

## Follow the recommended order of works

- » Mount water resistant boards on the walls where services and plumbing are to be installed.
- » Install air ventilation pipes first.
- » Fix services and plumbing to the boards.
- » Carry out the electrical installation. Prepare indents in the straw, with pegs and clay plaster behind the socket.
- » Consult with EcoCocon before drilling holes in a stud or creating a recess for electrical conduit.
- » Staple 1/4 inches wood-fibre board onto all studs and timber elements (supplied).
- » For plaster surfaces, mount rails (timber, plastic, or aluminum) at the floor, ceiling, and openings to ensure full coverage and neat edges. A timber rail can later secure the skirting board.
- » Mount interior sills before applying base coat plaster or sometimes before final coat.
- » Apply base coat plaster.



# Electrical Installations

**!** Electrical installation must strictly follow National Regulations.

01

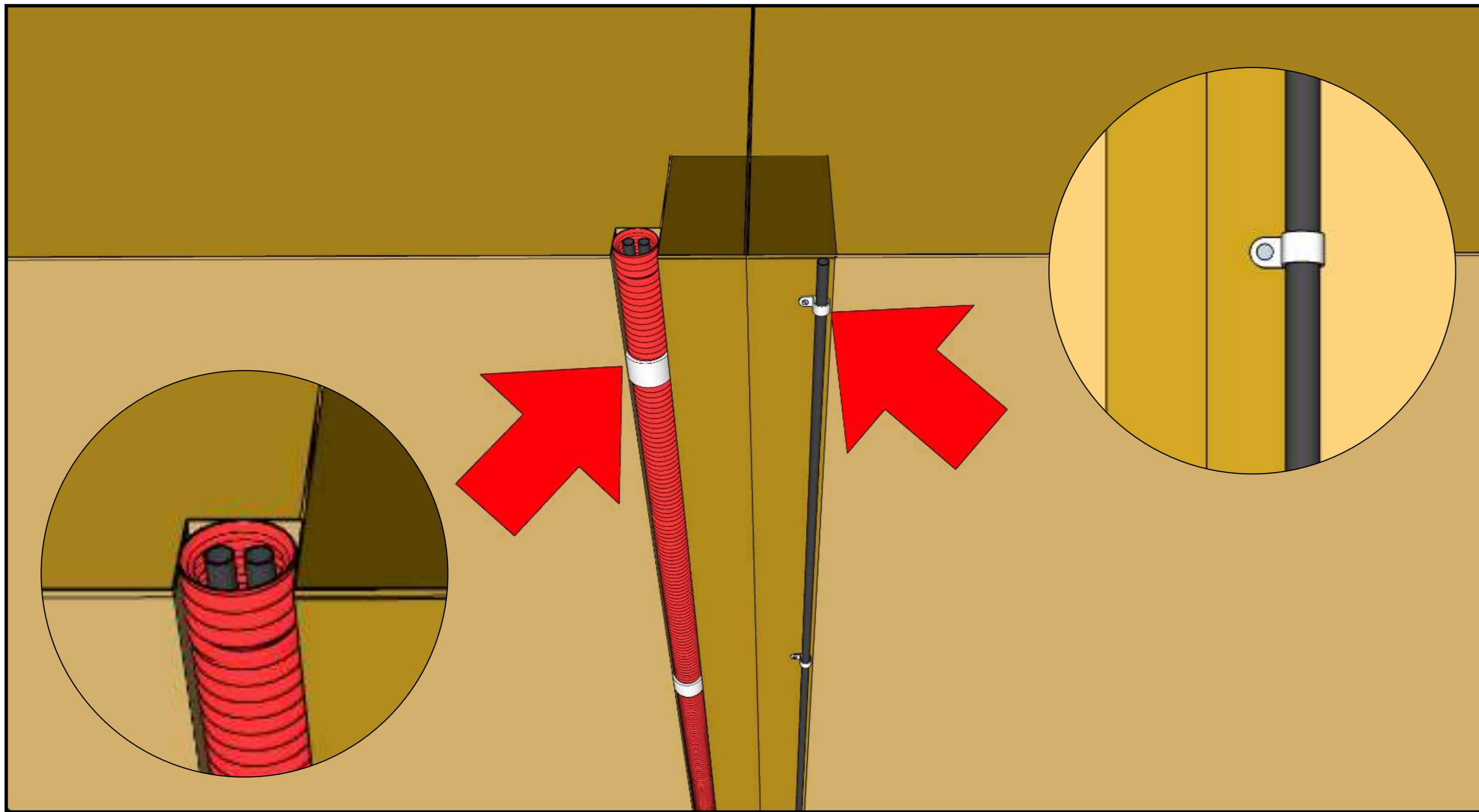

Secure wiring with nail clips on studs or use a protective conduit (Metal-Clad (MC) cables in US), buried in the straw, attached from the side.

02

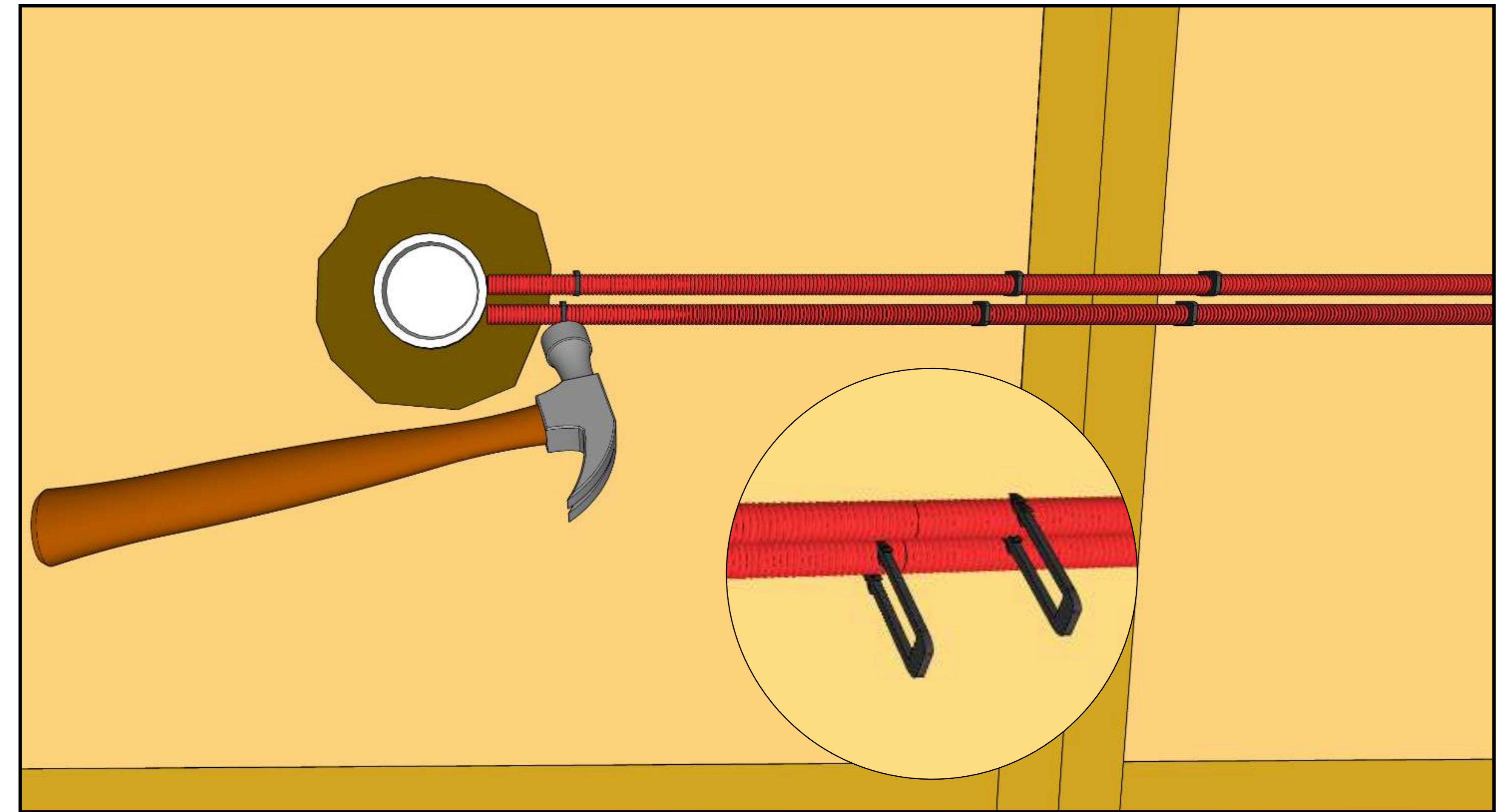

Attach electrical wiring with plastic anchor clips to the straw surface.

03

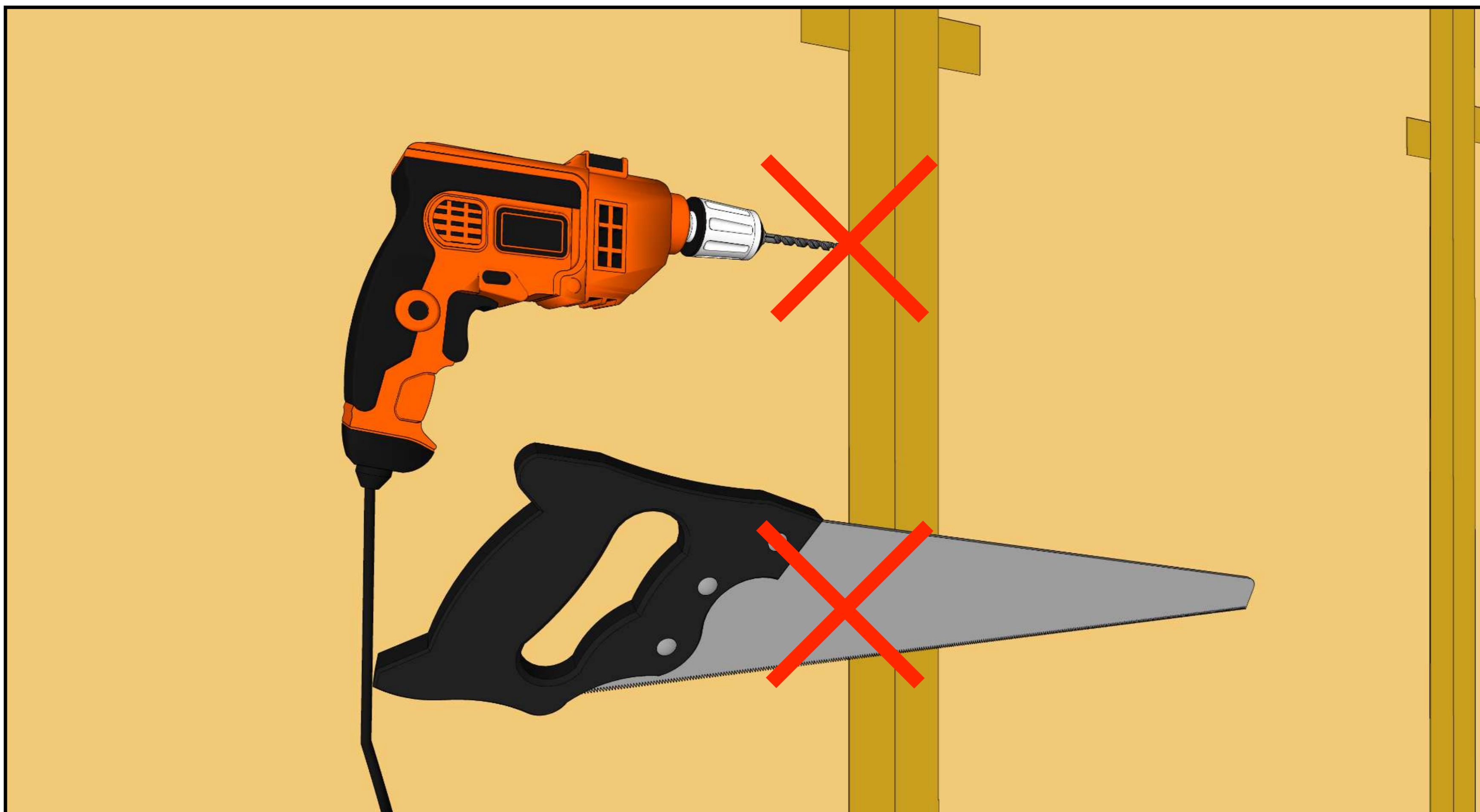

Do not drill through studs or make notches during construction; always consult with an EcoCocon structural engineer.

04

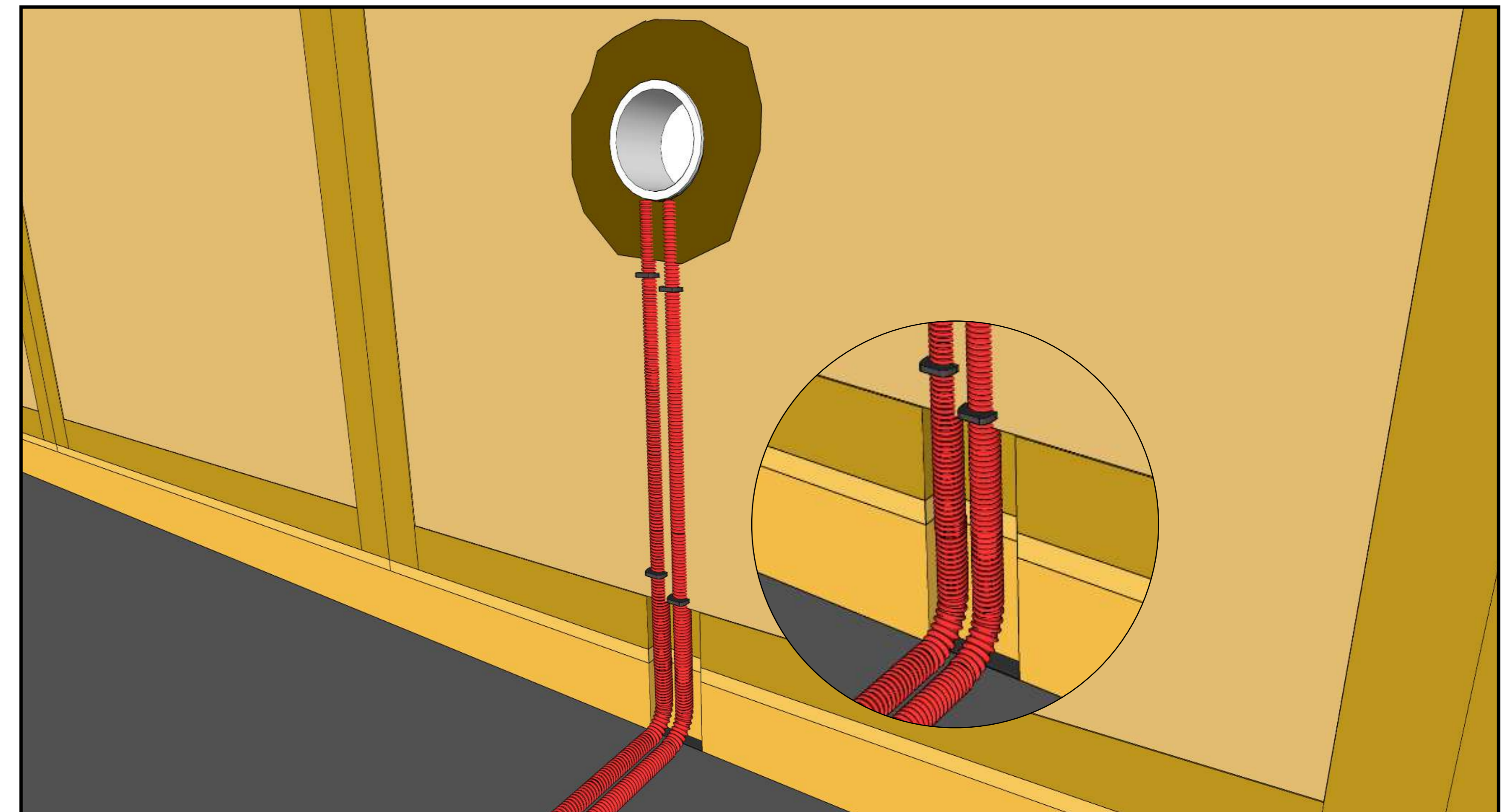

It is possible to cut a notch into the bottom of the panels and base plate.





Electrical installation must strictly follow National Regulations.

05

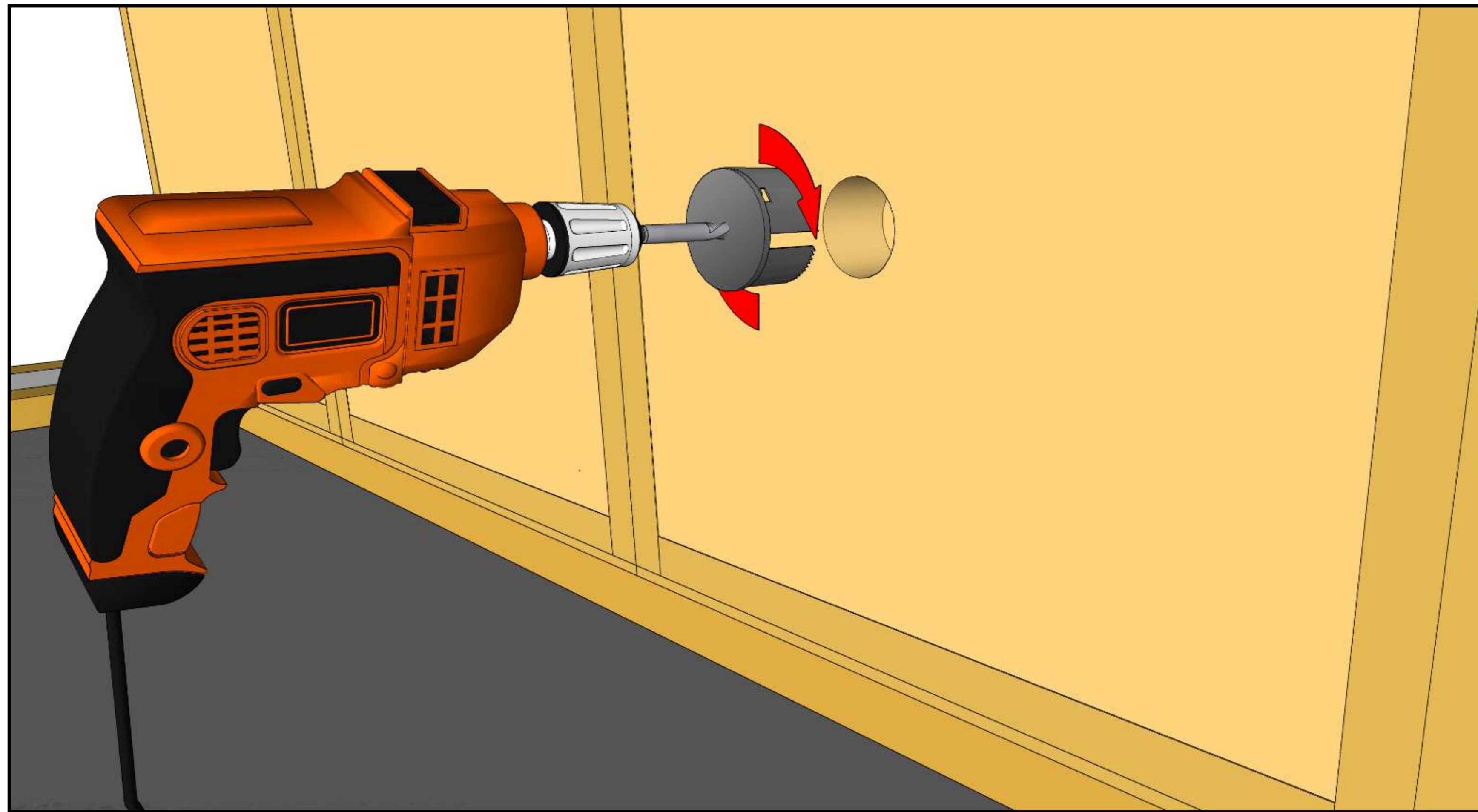

For installing a socket, route out an indent in the straw.

06

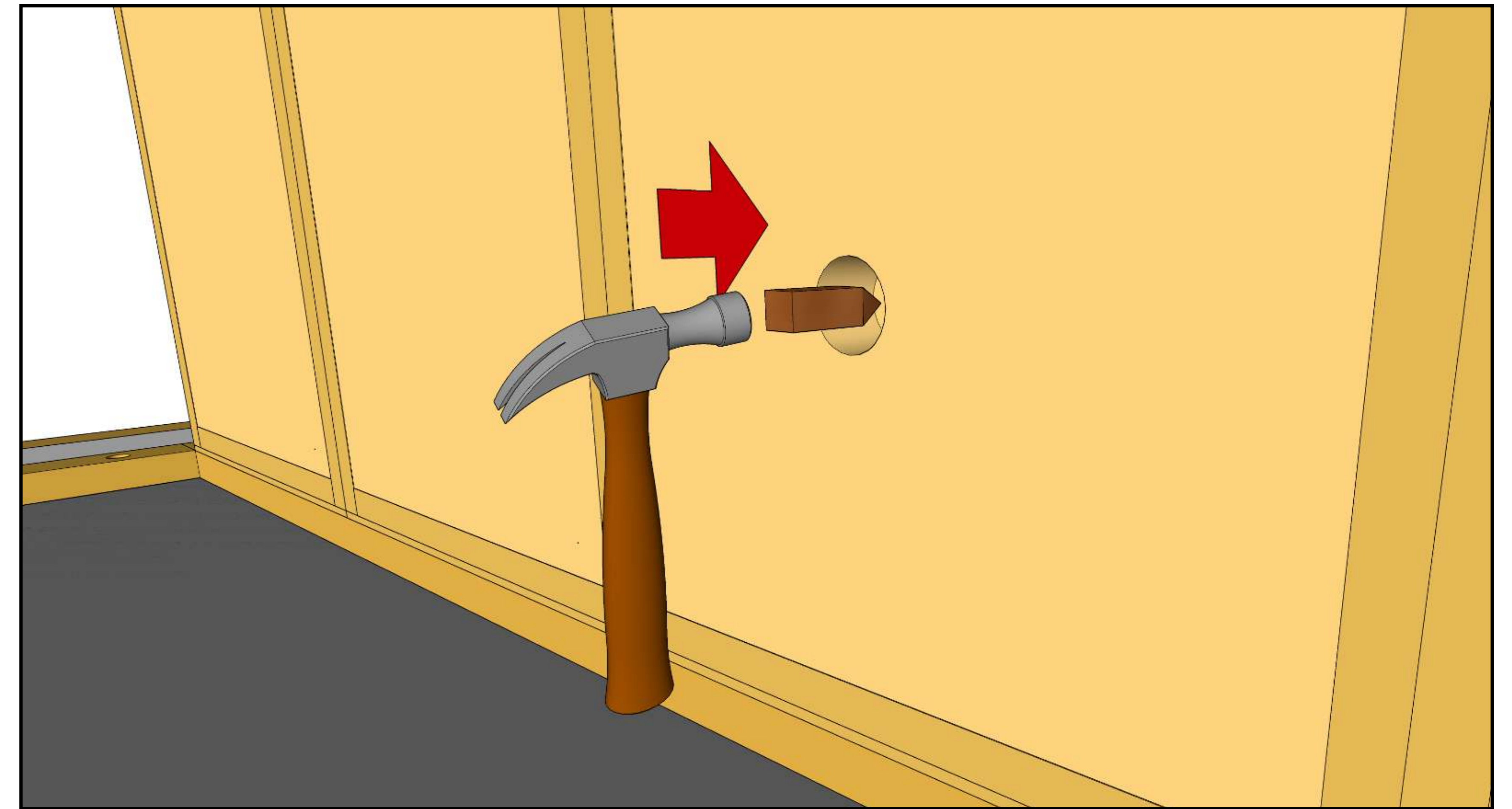

Hammer a sharpened wooden peg (approximately  $\frac{3}{16} \times \frac{3}{16} \times 7 \frac{7}{8}$  inches) into the straw wall.

07

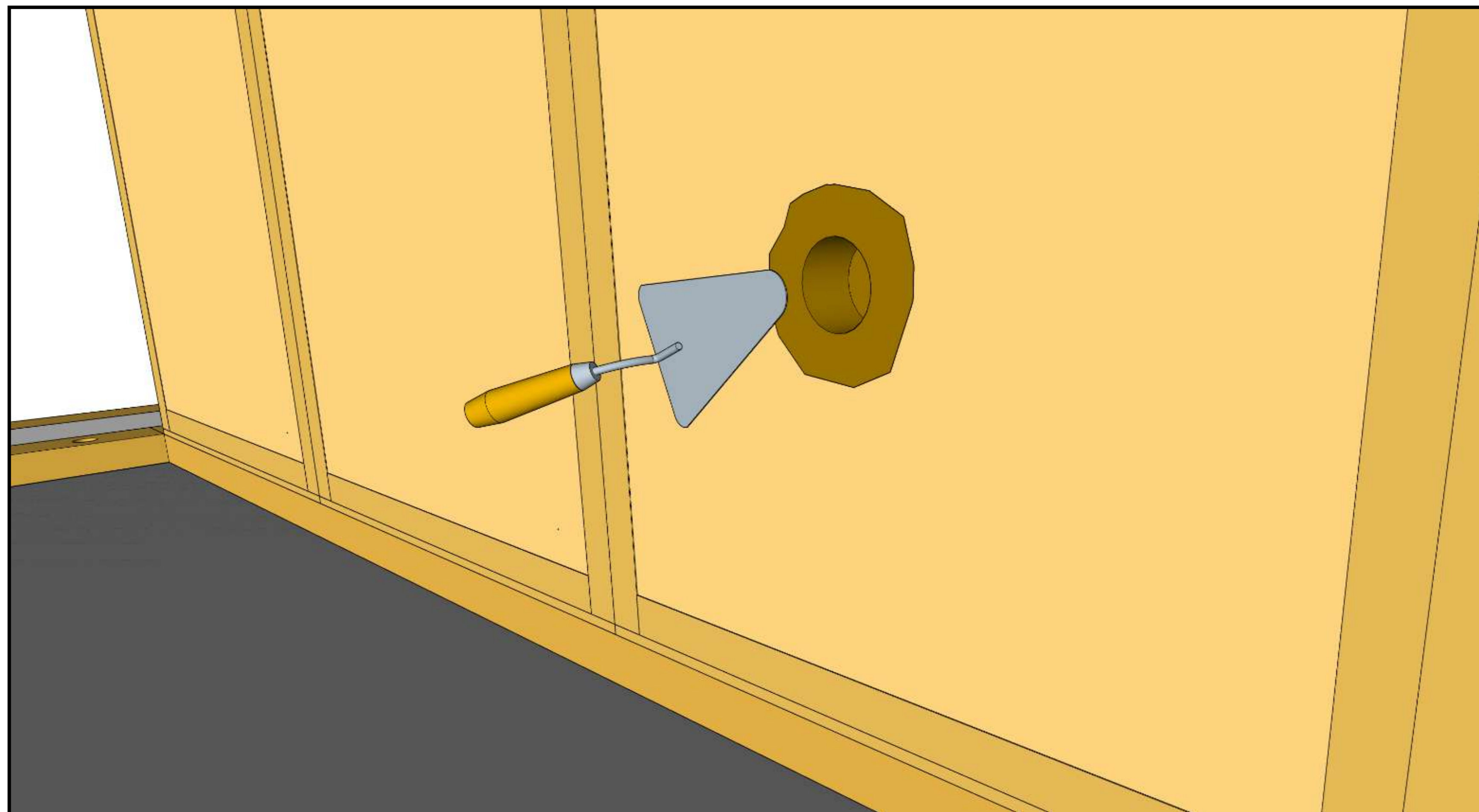

Add plaster (clay/gypsum) behind the socket.

08



Fix the socket with a screw into the peg.





Electrical installation must strictly follow National Regulations.

09

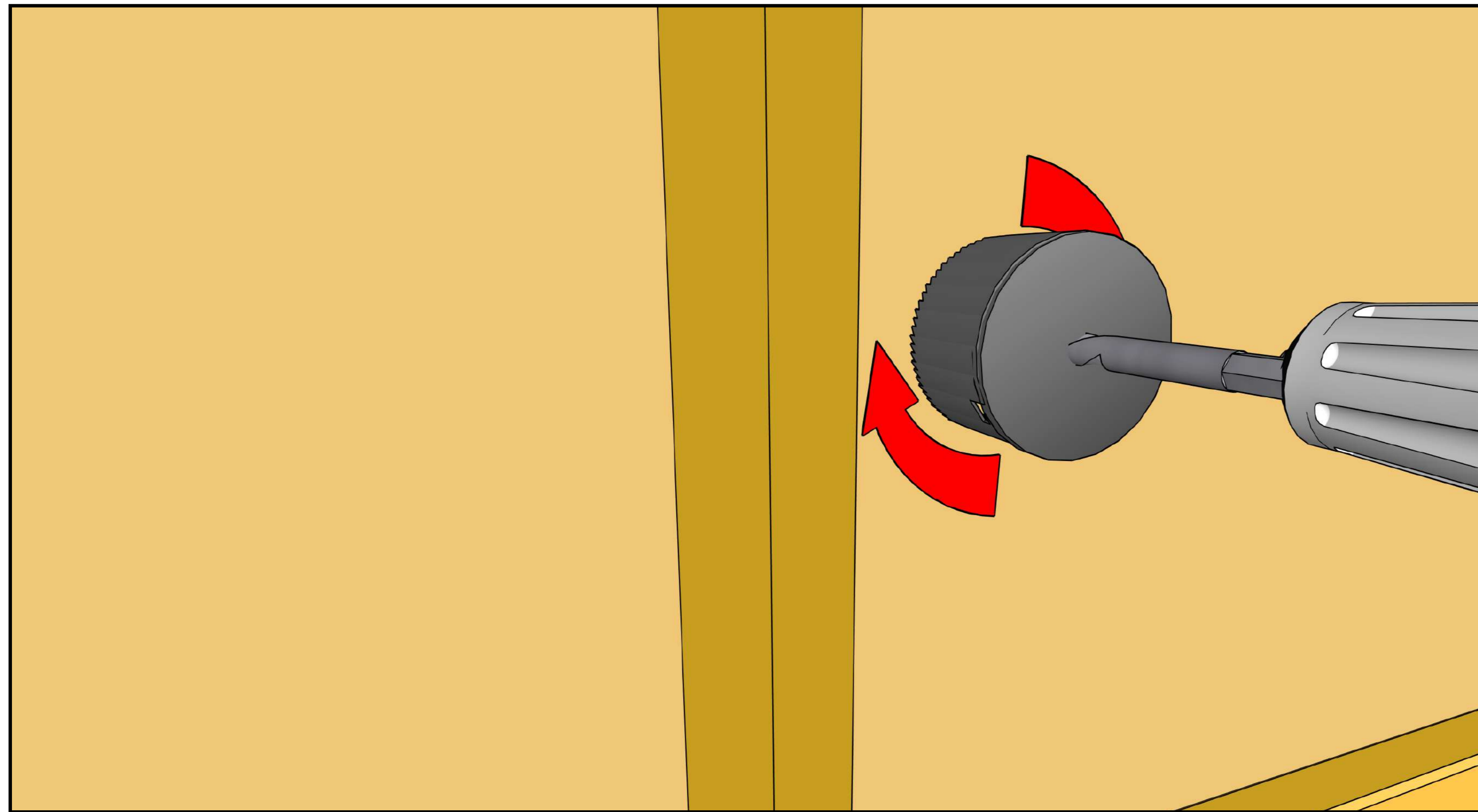

For socket installation next to a stud, carve an indent in the straw.

10

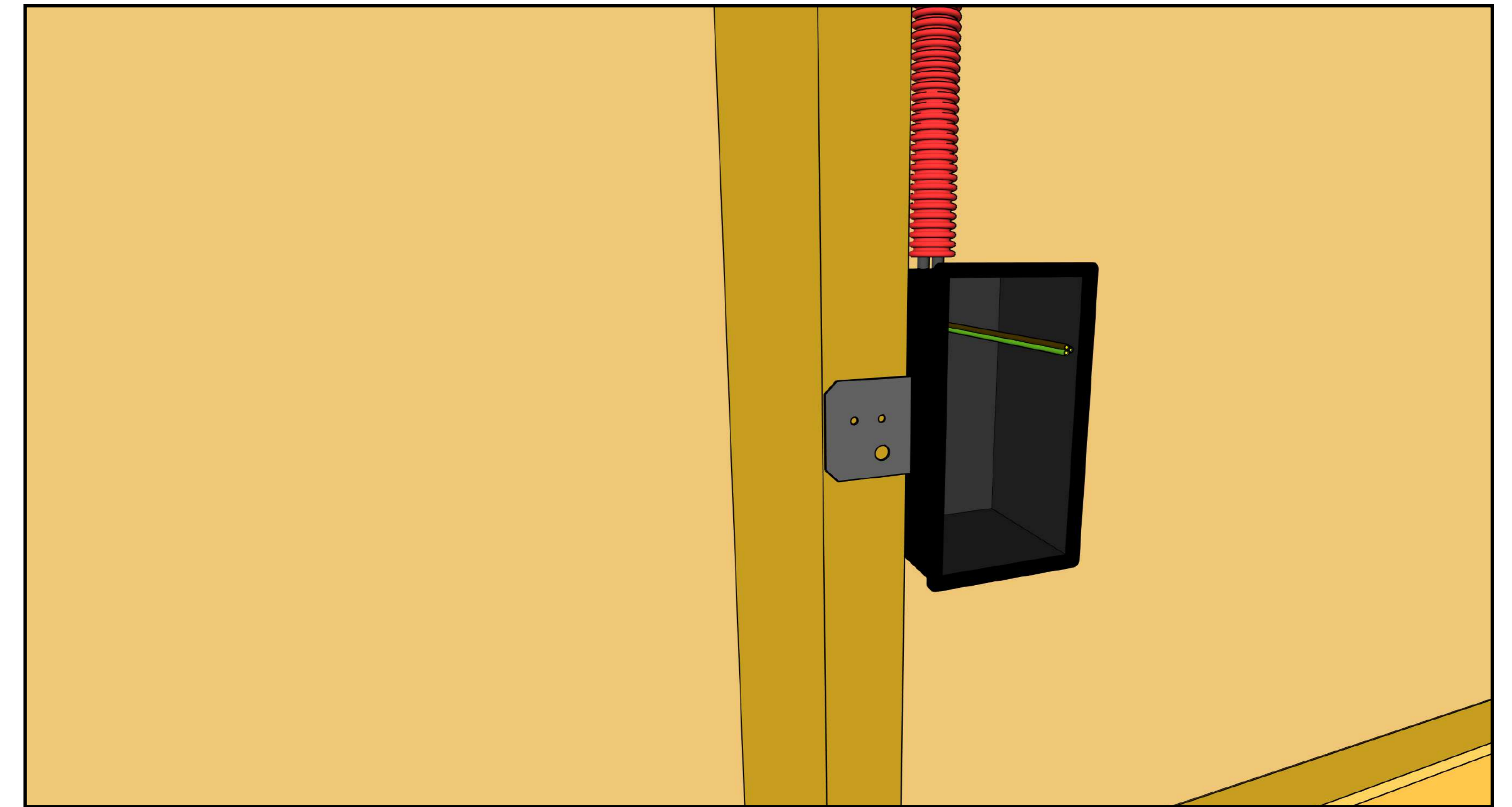

Fix the socket (for MC cables in the US) to the side of a stud using screws.



# Service Void for Plumbing

01

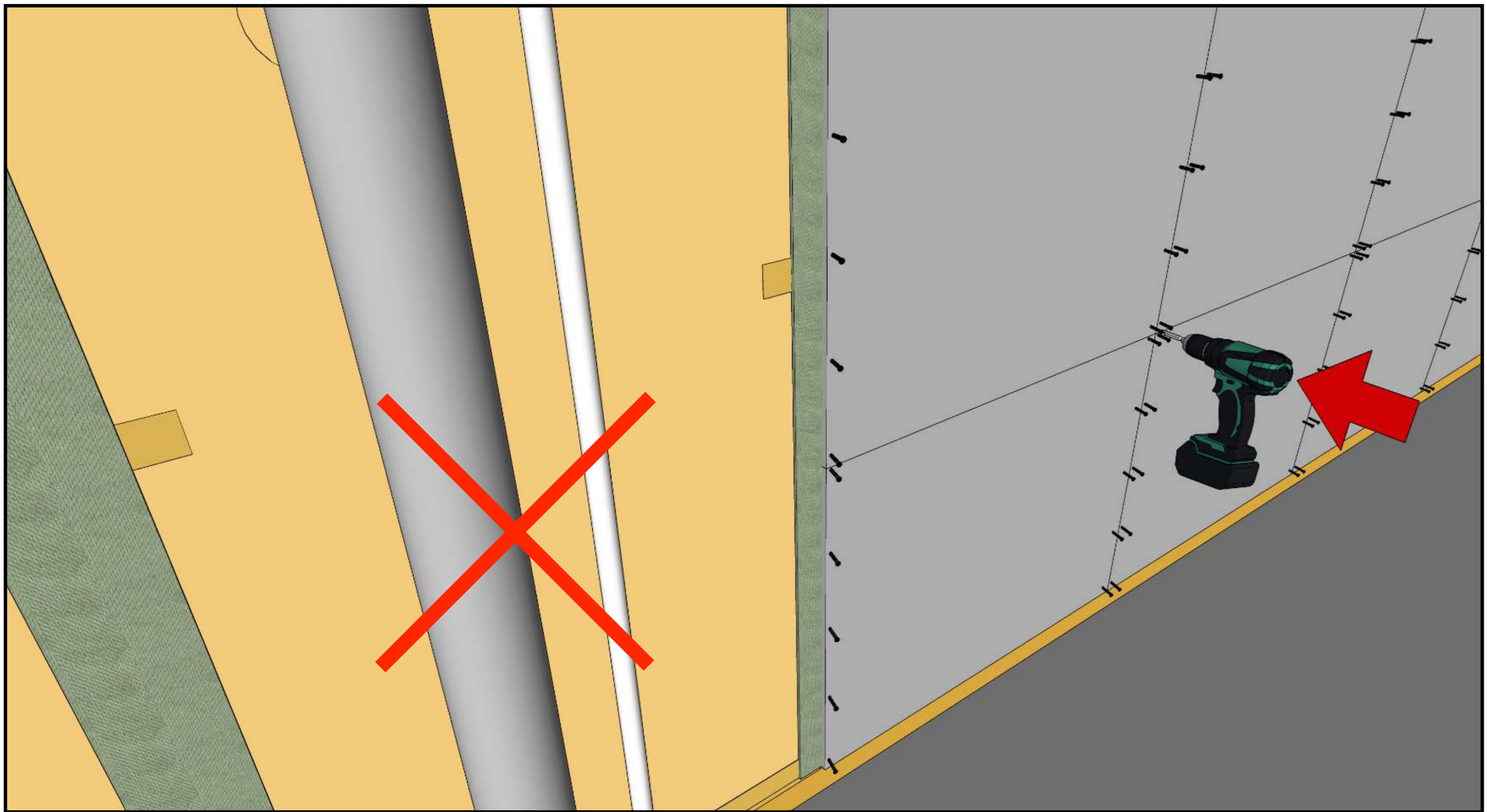

Do not place plumbing services in the straw. First staple 1/4 inches wood fibre board onto the timber structure then use a water-resistant board behind the plumbing.

02

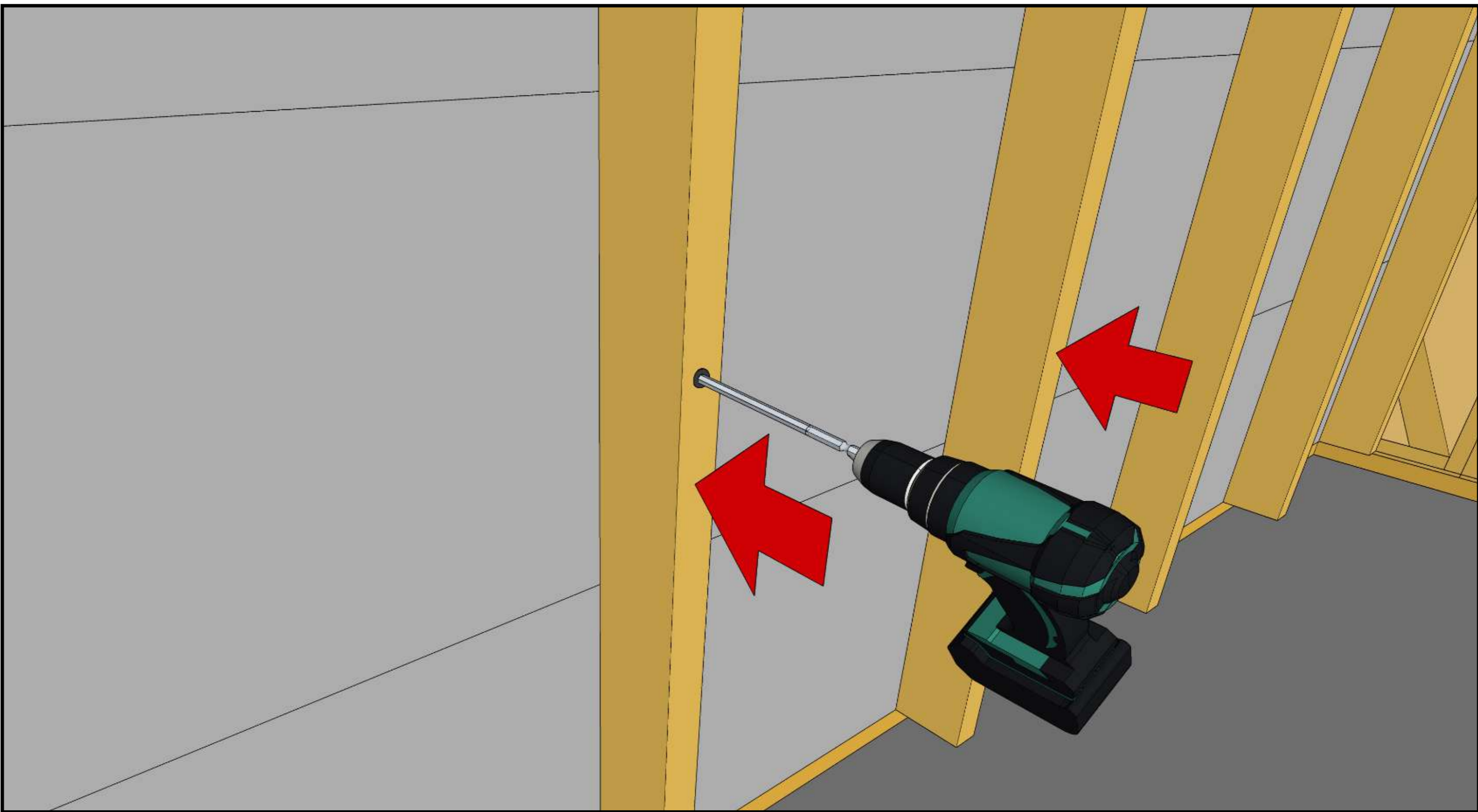

Create a service void to install services.

03

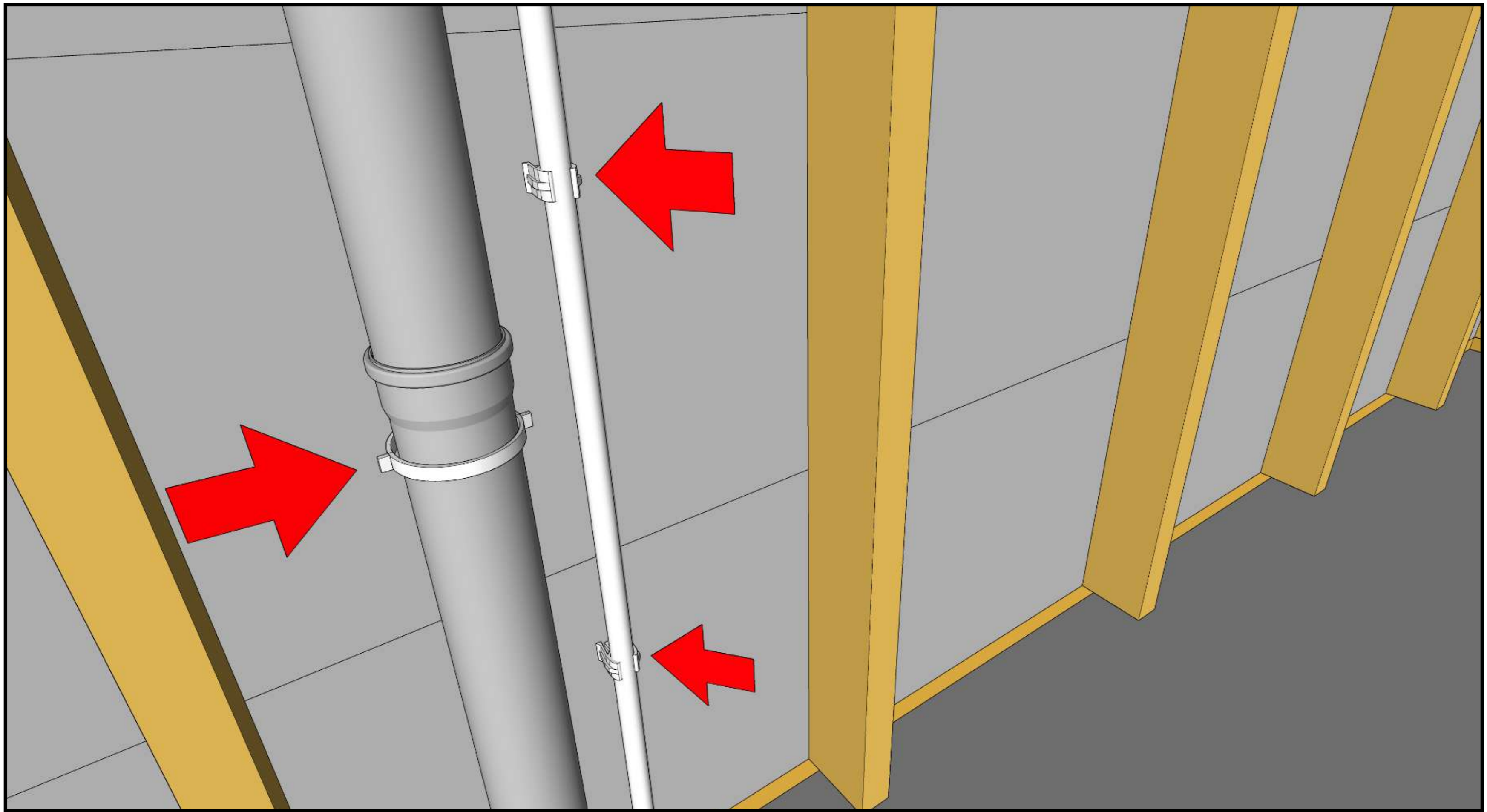

Fix services to the board.

04

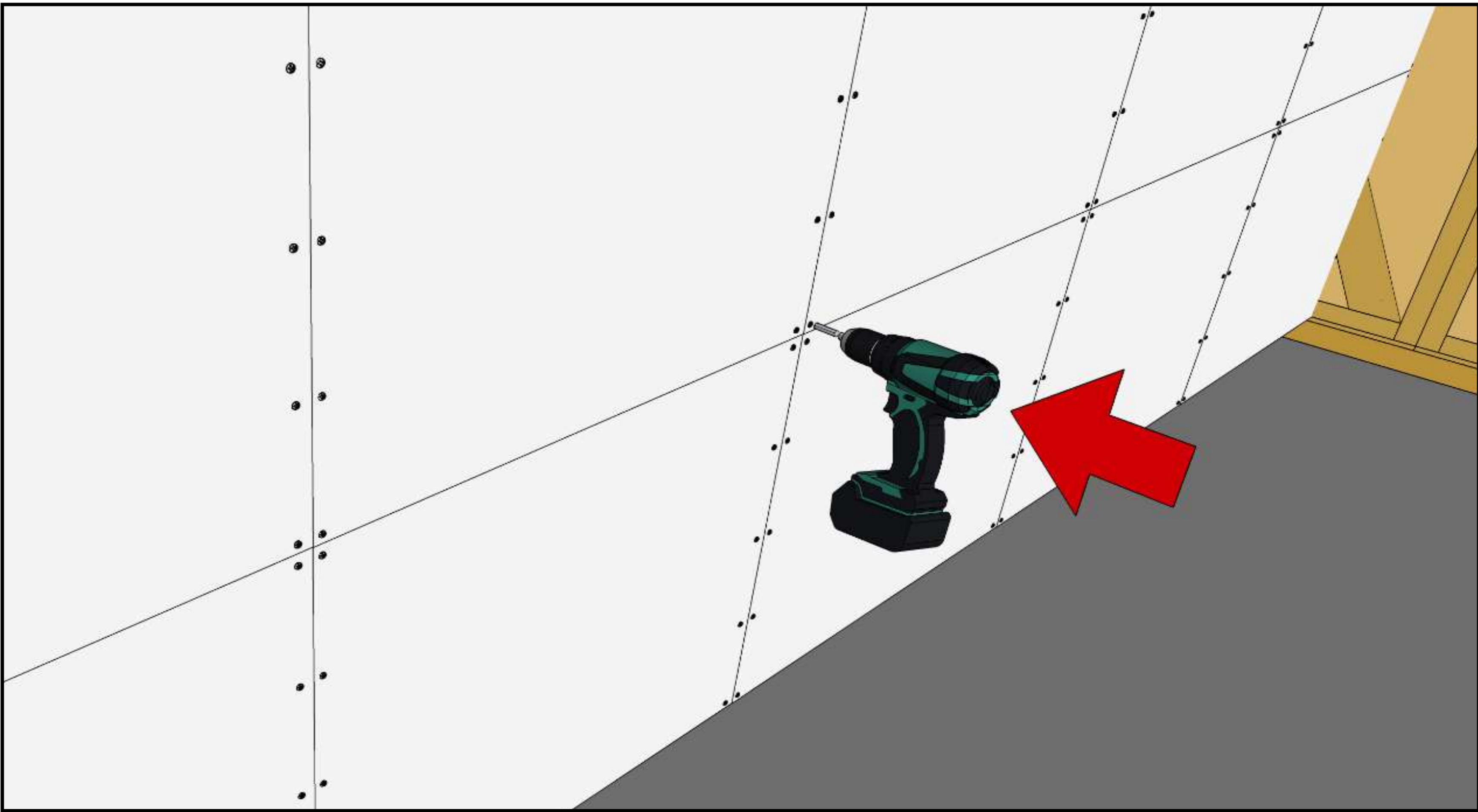

Cover the services void.



# Interior Clay Plaster System

01

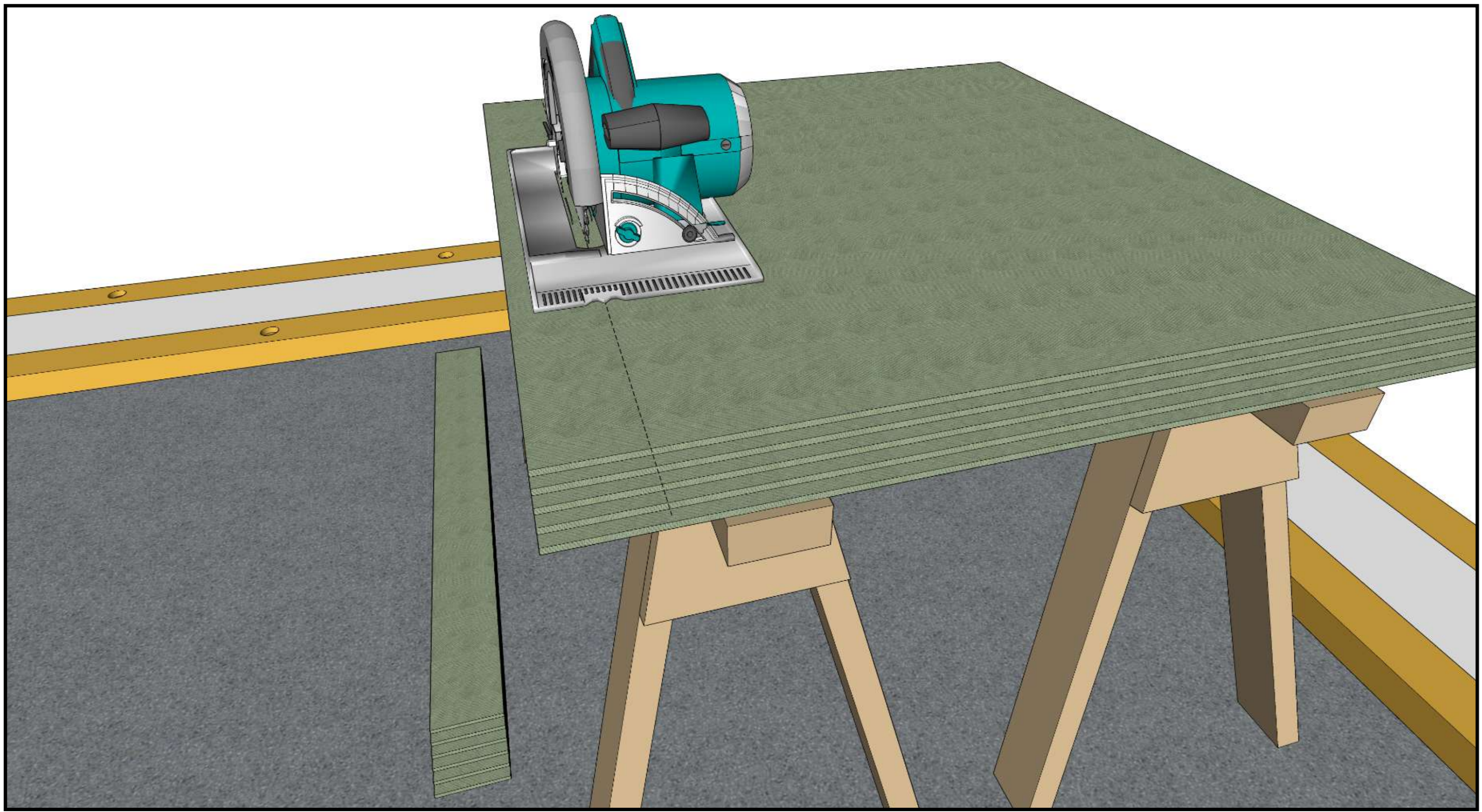

Cut 1/4 inches thick wood fibre board into strips to cover the timber structure.

02

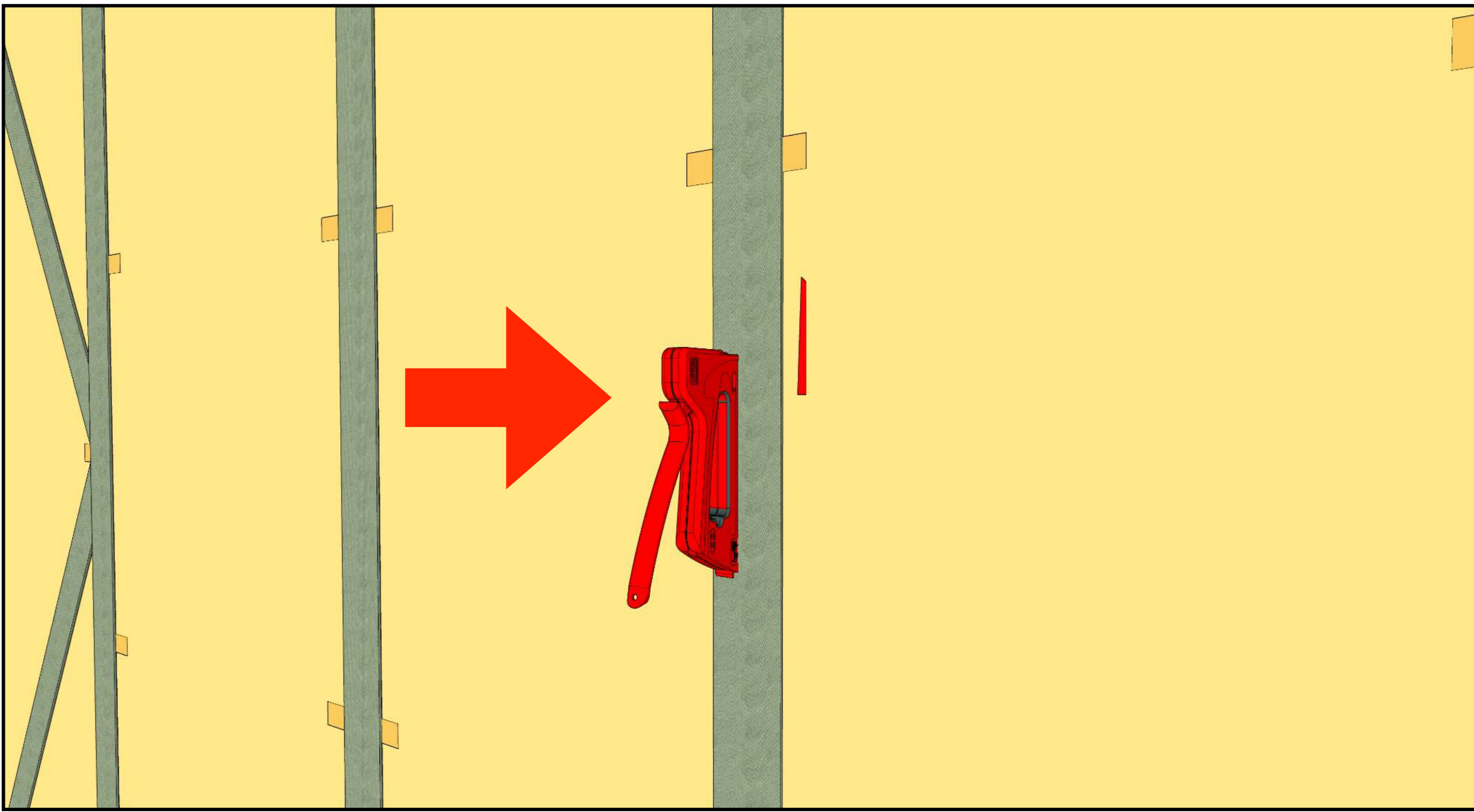

Staple wood fibre board strips onto all studs and timber elements.

03

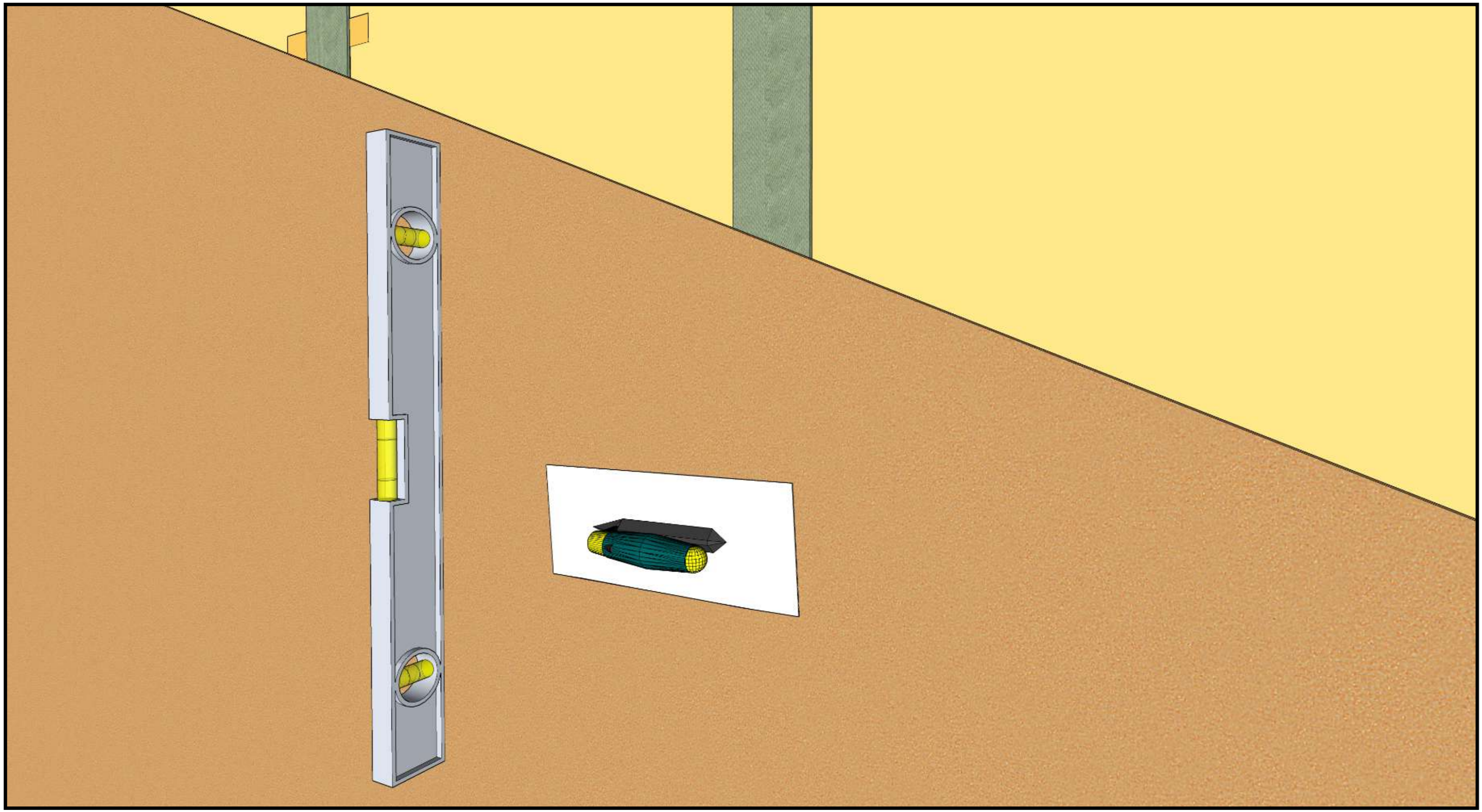

Apply the base coat plaster to a depth of 3/4 - 1 inches. This can be applied in one or two coats, with a reinforcing mesh either between 2 layers or into the top surface.

04

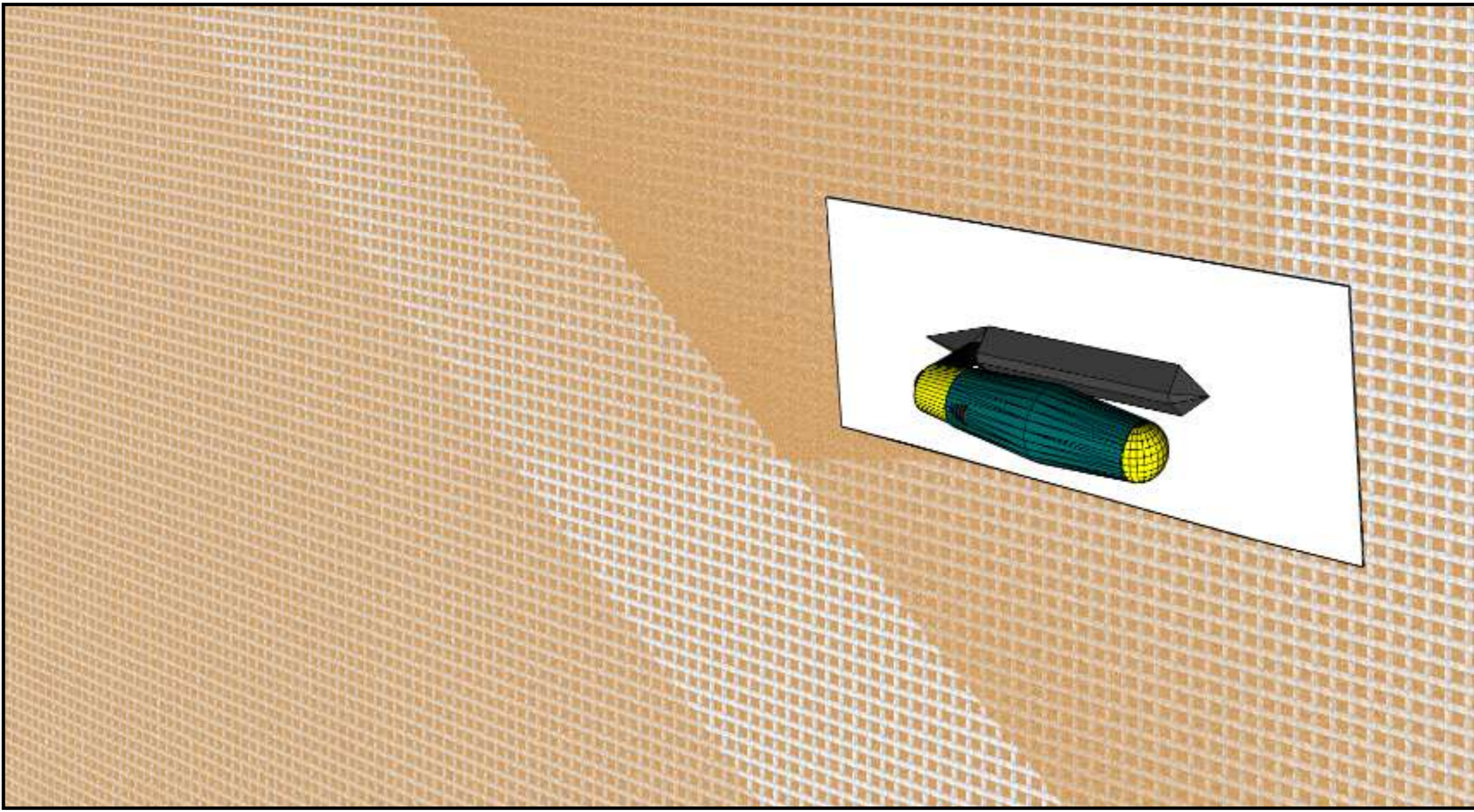

The mesh should be pressed into the wet surface and worked into the plaster with a float.



05

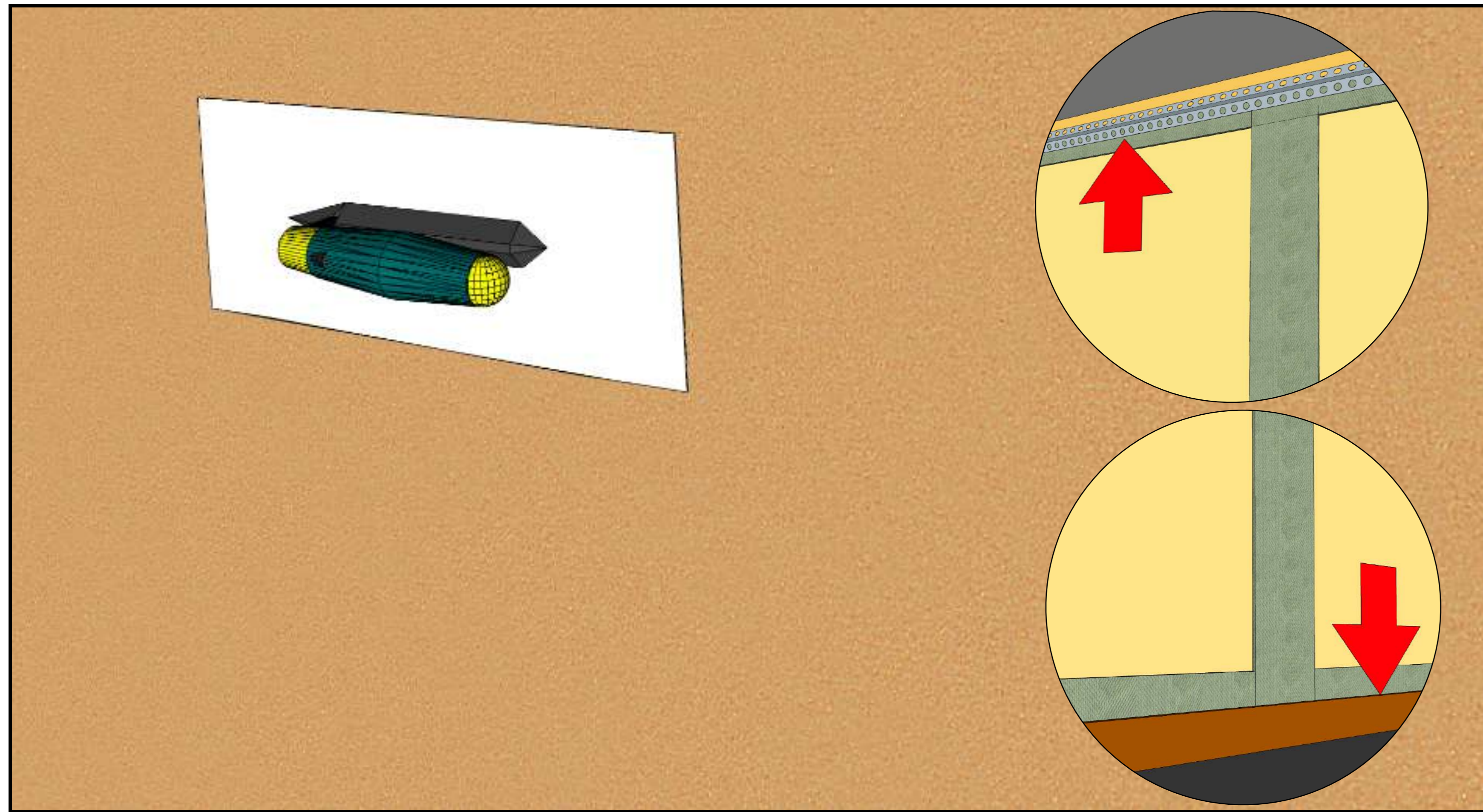

Cover all the panels with plaster from top to bottom. Use a plaster rail (aluminium, timber) as a guide at the ceiling and at the floor to ensure good detailing.

06

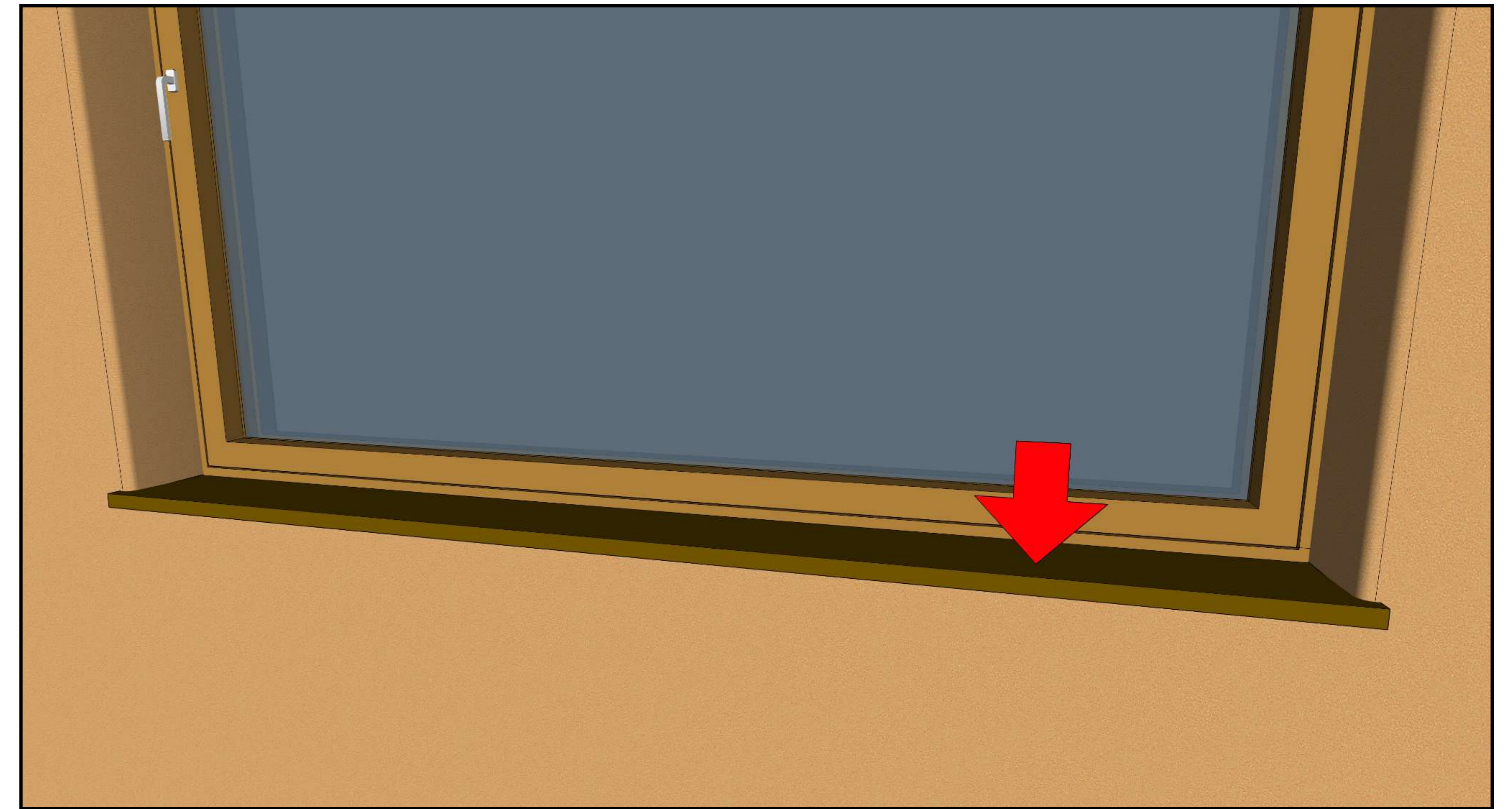

Mount interior sills before applying final coat.

07

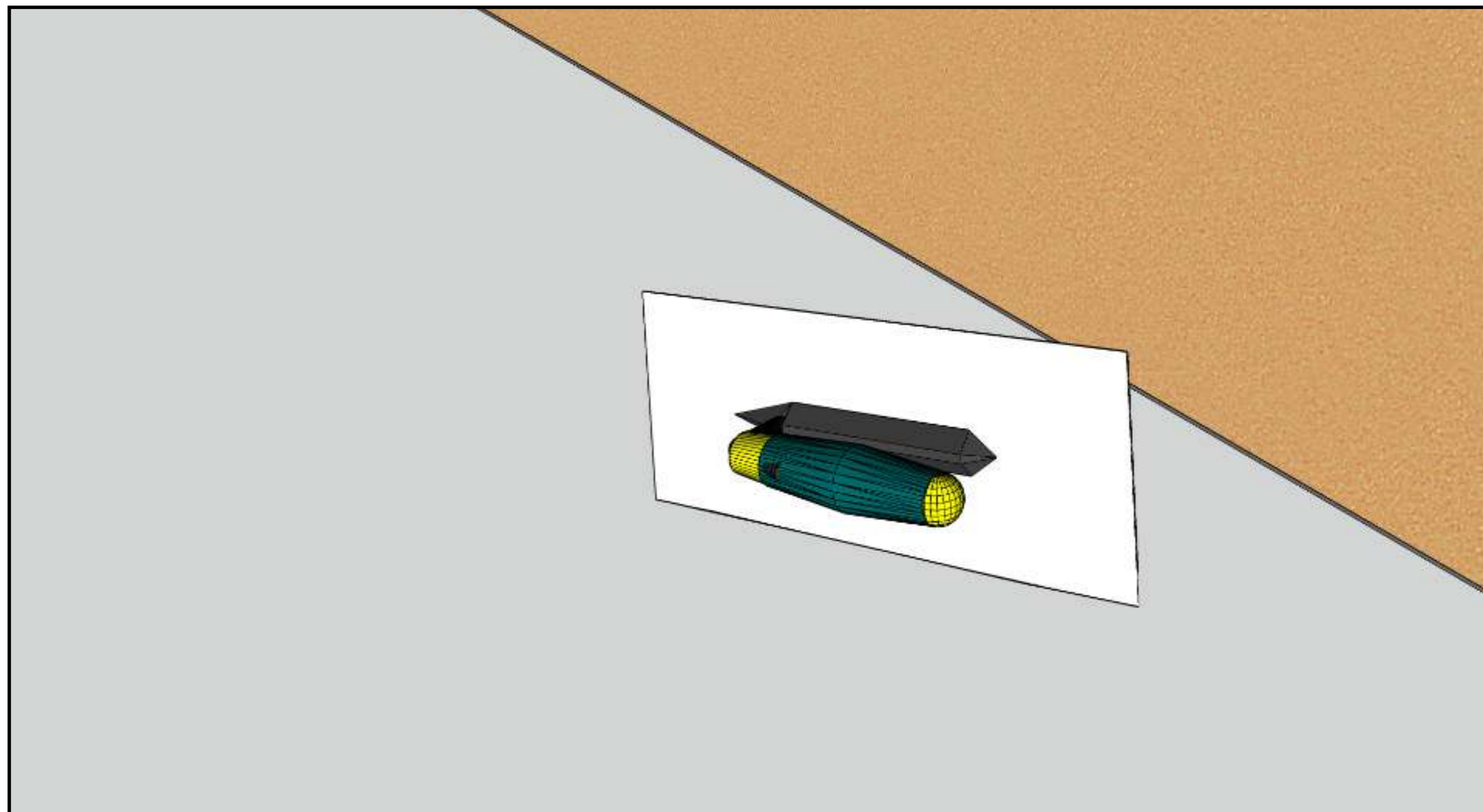

Apply a fine clay plaster. Refer to the manufacturer's technical guide.

08

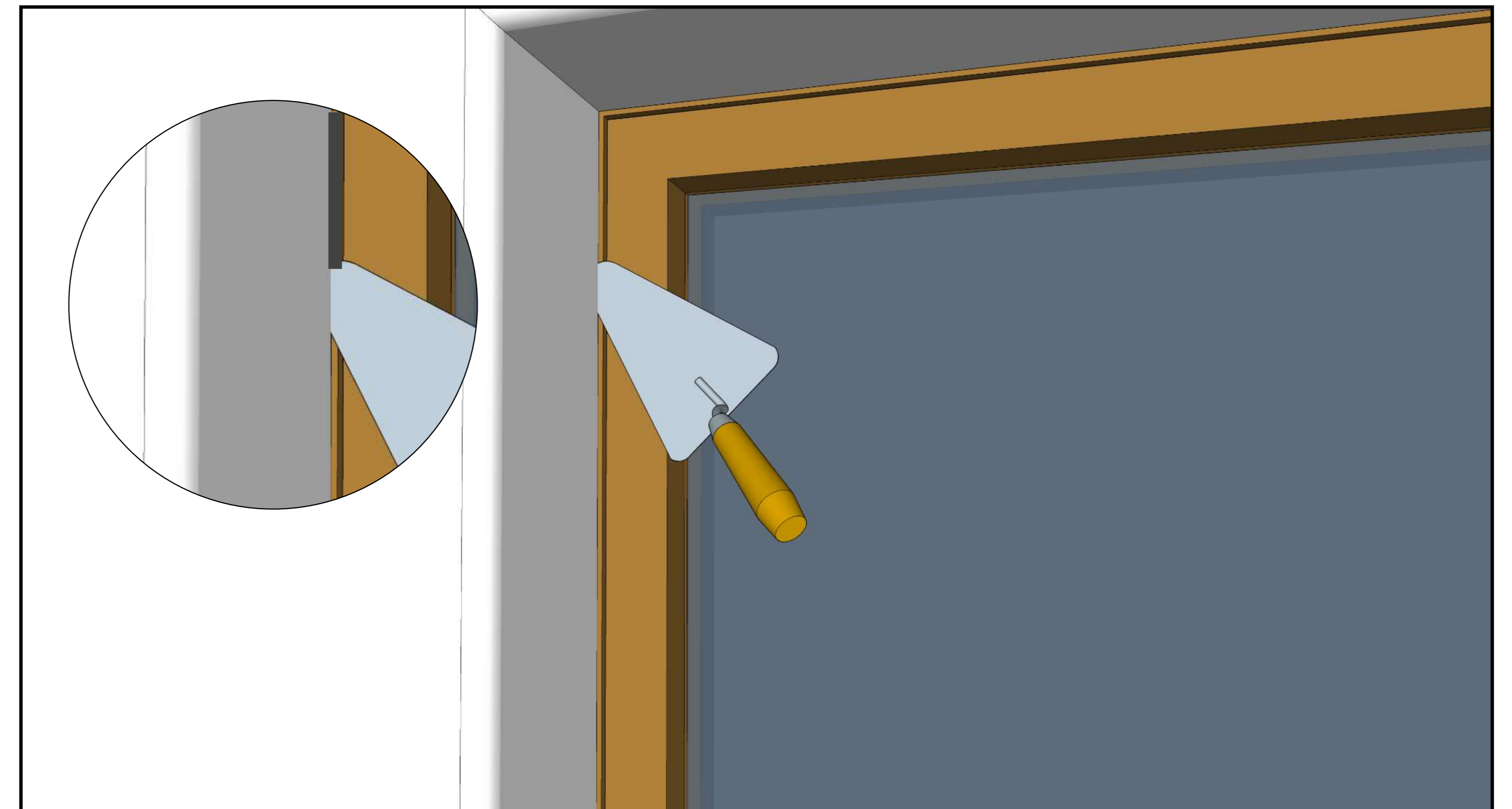

Good detailing: make a small notch next to connections to avoid uneven shrinkage cracking.

# Wall Mounts

01

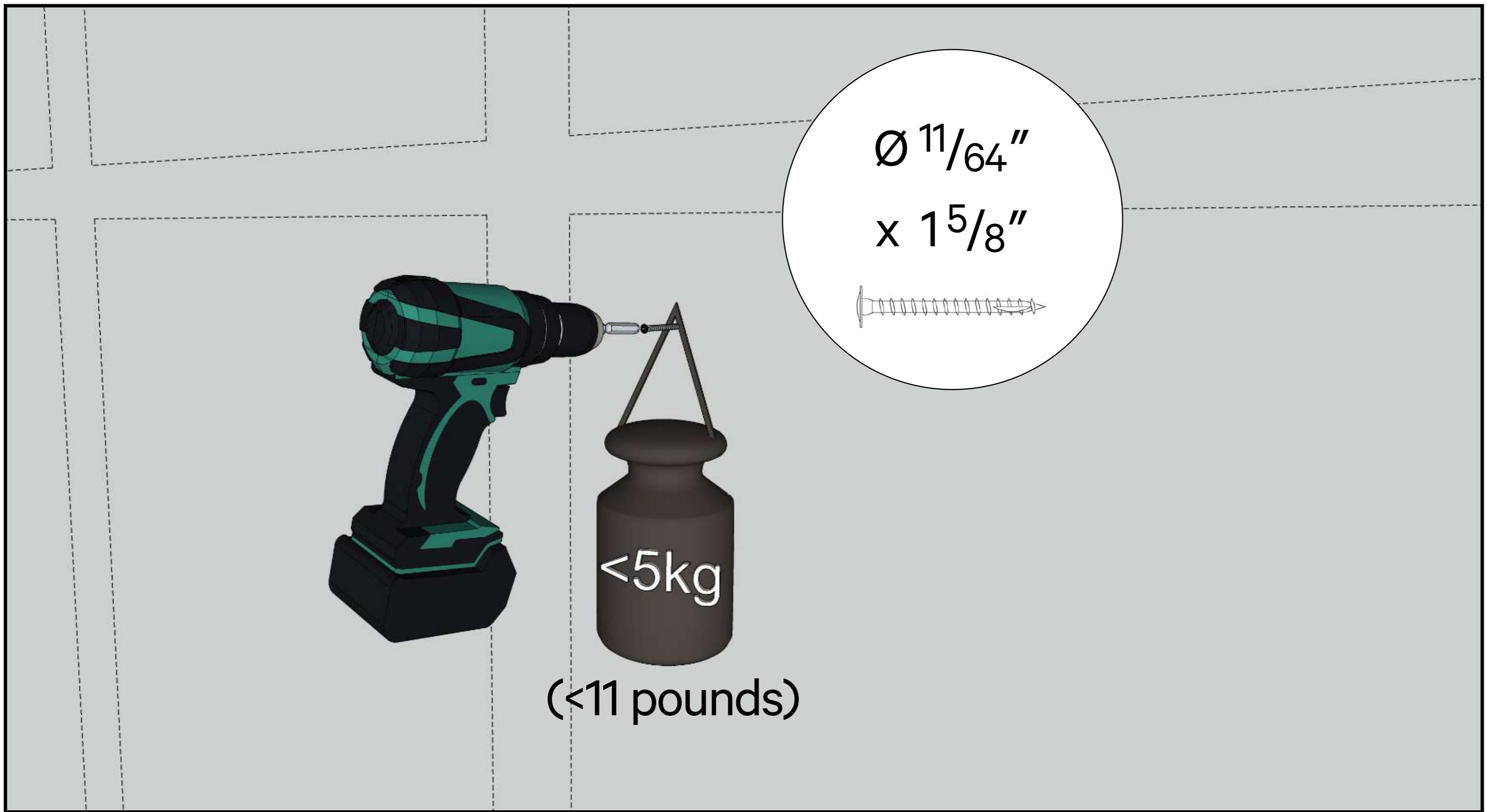

For up to 11 pounds load, place a 11/64 x 1 5/8 inches full thread screw directly in the clay or gypsum plaster. The closer the load is to the wall the better.

02

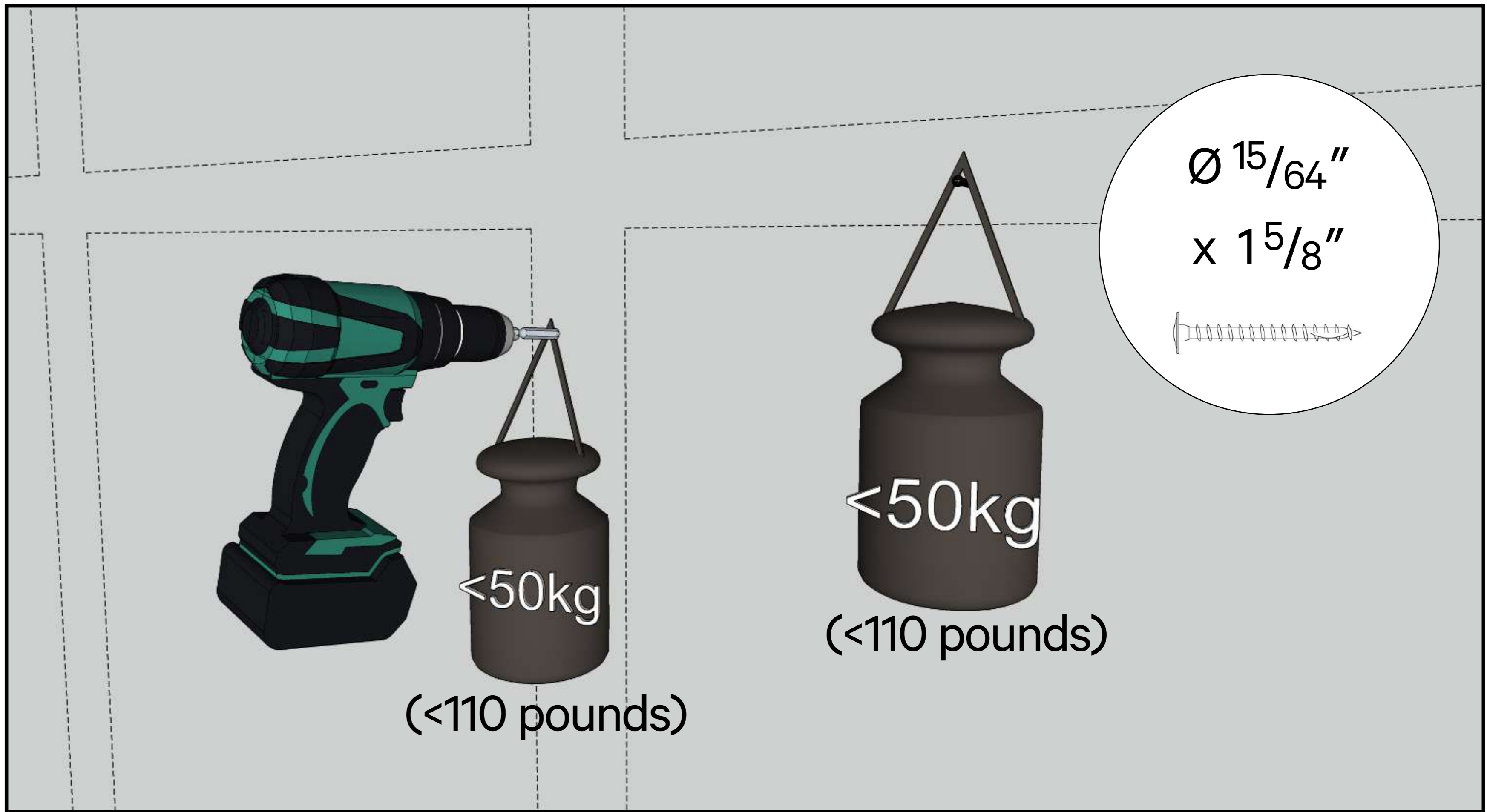

Loads heavier than 110 pounds, fix directly into panel construction. A 15/64 inches diameter screw can hold up to 110 pounds fixed in studs or horizontal elements.

03

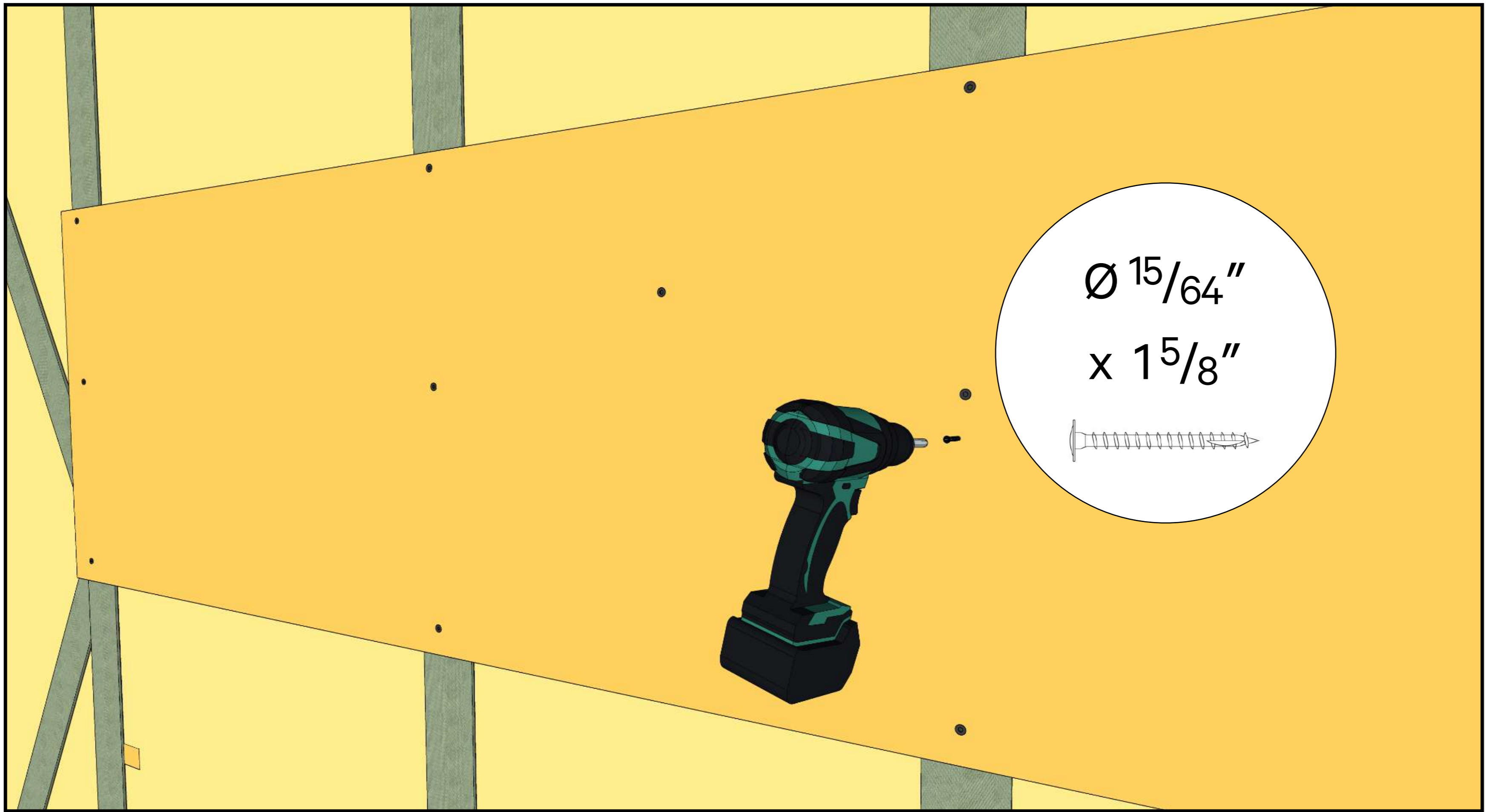

For more mounting options, fix a board/timber to the studs using at least two 15/64 inches diameter screws per stud.

04

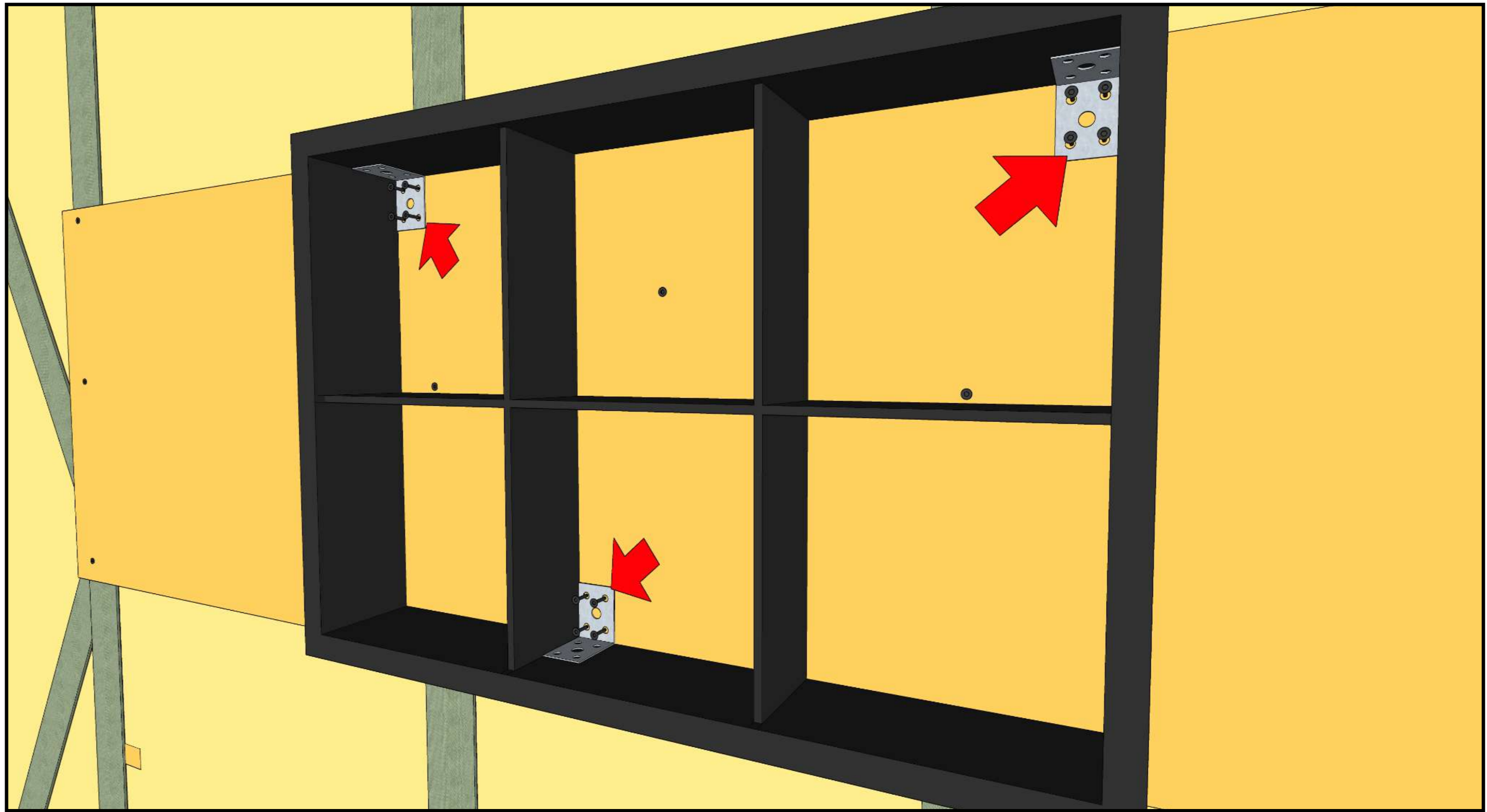

Fix shelves or cupboards to the board.



